

50D (Pneumatic) Electronic pressure switch

-1 ... 0 bar, -1 ... 1 bar, 0 ... 6 bar, 0 ... 10 bar, 0 ... 12 bar

- Fast error detection via multi-colour display
- Easy to use pressure switch with clear display and intuitive programming
- Flexible mounting - DIN Rail or wall mounting
- Optional connection; rear or base
- LABS free materials, conforming to RoHS
- ATEX conforming to Zone 2, gases (Cat. II 3G, Ex nA II T6 X) and Zone 22, dusts (Cat. II 3G, Ex tD A22 IP65 T80°C X).



ATEX^{Ex}

Technical data

Medium:

Compressed air, filtered (40 µm), lubricated and non-lubricated

Mounting:

Optional

Pressure ranges:

-1 ... 0 bar, -1 ... 1 bar
0 ... 6 bar, 0 ... 10 bar, 0 ... 12 bar

Over pressure safety:

6 bar (-1 ... 0; -1 ... 1 bar)
15 bar (0 ... 6; 0 ... 10 bar)
16 bar (0 ... 12 bar)

Temperature:

Fluid/Ambient
0 ... + 60°C
ATEX: 0 ... +50°C

Air supply must be dry enough to avoid ice formation at temperatures below +2°C

Accuracy:

≤ 2% FS* [incl. temperature drift]
≤ 1,5% (+10 ... 30°C)

Repeatability:

≤ 0,2% FS*

Switching point/Reset point:

Adjustable up 0 ... 100% FS*

Display:

Pressure units bar, PSI, KPa, MPa, InHg Vacuum

Linearity analogue port:

≤ 0,5% FS*

Degree of protection

acc. to EN 60529:

IP65 (with plug mounted)

Shockproof:

30 g, xyz,
DIN EN 60068-2-27 (11 ms)

Vibrationproof:

5 g, 10 ... 150 Hz, xyz,
DIN EN 60068-2-6

Weight:

0,05 kg

Materials:

Housing and display:
PC-GF10
Seals: FKM
Connector (M12 x 1):
nickel plated brass

* full scale

Electrical parameters

Electrical connection:

M 12 x 1

Power supply:

UB = 24 V d.c. (17 ... 30 V d.c.)

Current consumption:

≤ 20 mA, without outputs

Analogue power output (per switch selectable):

0 - 10 V: IL max. ≤ 3 mA
4 - 20 mA: RL2 ≤ 600 Ω

Switch output:

PNP high: UB - 1,5 V low: 0 V
NPN high: ≤ 30 V low: I(RL1) x 0,5 Ω

Switching current:

I_{max} ≤ 200 mA (short-circuit proof)

Switching time:

≤ 5 ms

Electromagnetic compatibility:

Emission to EN 61000-6-3:2007
Immunity to EN 61000-6-2:2005

Standard variants Pressure switch

The electrical connectors are not included. Caution:
When used in Ex application areas the following connectors should be used 0523058, 0523053, 0523057 and 0523052 only, otherwise the device will lose its Ex certification.

Pressure range	Port size	Output signal	Model
0 ... 6 bar	G1/4	2 x PNP	DS-E1P06F4B2PR00
		2 x NPN	DS-E1P06F4B2NR00
		1 x PNP + 1 x analog	DS-E1P06F4BPAR00
		1 x NPN + 1 x analog	DS-E1P06F4BNAR00
	Push-In fitting ø 4 mm	2 x PNP	DS-E1P06P4B2PR00
		2 x NPN	DS-E1P06P4B2NR00
		1 x PNP + 1 x analog	DS-E1P06P4BPAR00
		1 x NPN + 1 x analog	DS-E1P06P4BNAR00
0 ...10 bar	G1/4	2 x PNP	DS-E1P10F4B2PR00
		2 x NPN	DS-E1P10F4B2NR00
		1 x PNP + 1 x analog	DS-E1P10F4BPAR00
		1 x NPN + 1 x analog	DS-E1P10F4BNAR00
	Push-In fitting ø 4 mm	2 x PNP	DS-E1P10P4B2PR00
		2 x NPN	DS-E1P10P4B2NR00
		1 x PNP + 1 x analog	DS-E1P10P4BPAR00
		1 x NPN + 1 x analog	DS-E1P10P4BNAR00
0 ...12 bar	G1/4	2 x PNP	DS-E1P12F4B2PR00
		1 x PNP + 1 x analog	DS-E1P12F4BPAR00
	Push-In fitting ø 4 mm	2 x PNP	DS-E1P12P4B2PR00
		1 x PNP + 1 x analog	DS-E1P12P4BPAR00

Vacuum switch

Pressure range	Port size	Output signal	Model
-1 ... 0 bar	G1/4	2 x PNP	DS-E1V10F4B2PR00
		2 x NPN	DS-E1V10F4B2NR00
		1 x PNP + 1 x analog	DS-E1V10F4BPAR00
	Push-In fitting ø 4 mm	2 x PNP	DS-E1V10P4B2PR00
		2 x NPN	DS-E1V10P4B2NR00
		1 x PNP + 1 x analog	DS-E1V10P4BPAR00
-1 ... 1 bar	G1/4	2 x PNP	DS-E1V11F4B2PR00
		2 x NPN	DS-E1V11F4B2NR00
	Push-In fitting ø 4 mm	2 x PNP	DS-E1V11P4B2PR00
		2 x NPN	DS-E1V11P4B2NR00

Options selector

Pressure range (bar)	Substitute
-1 bis 0	V10
-1 bis 1	V11
0 bis 6	P06
0 bis 10	P10
0 bis 12	P12

Port size	Substitute
G1/4	F4
ø 4 mm Push-In fittings	P4

DS-E1*****B***R00

Output signa	Substitute
2 x PNP	2P
2 x NPN	2N
PNP + analogue	PA
NPN + analogue	NA

For combinations of pressure switch variants consult our Technical Service. This options selector explains only the pressure switch variants. Additional variants/options are not possible.

Ordering information

Electronic pressure switch, pressure range 0 to 6 bar,
port size G 1/4, output signal 2 x PNP
Quote: DS-E1P06F4B2PR00

Accessories

Wall clip	Front frame	Front frame with keyboard cover	DIN rail (35 x 7,5)	Adaptor	NPT Adaptor
0523962	0524038	0524036	V10009-C00 (1 m)	0523951 (G1/4 ... G1/4) 0523950 (G1/4 ... G1/8)	0523953 (G1/4 ... 1/4 NPTF) 0523952 (G1/4 ... 1/8 NPTF)
Connector M 12 x 1 90°	90° (without Ex)	straight	Connector M 12 x 1 straight (without Ex)		
0523058 (2 m cable length, 4-core) 0523053 (5 m cable length, 4-core)	0523056 (without cable)	0523057 (2 m cable length, 4-core) 0523052 (5 m cable length, 4-core)	0523055 (without cable)		

2 X PNP

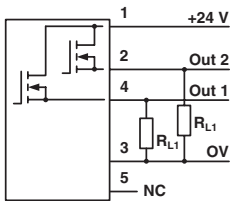

2 X NPN

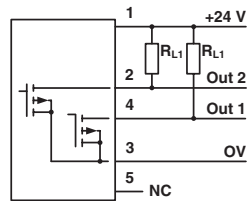

1 x PNP, 1 x analogue

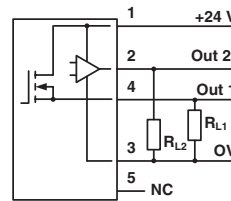

1 x NPN, 1 x analogue

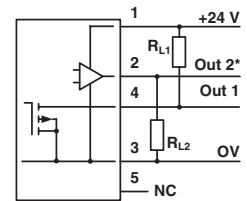

Electrical connection M 12 x 1

Electrical connection M 12 x 1 PIN-No.	Signal	Cable
1	+UB 24 V DC	brown
2	Out 2 (PNP; NPN; analogue 4-20 mA/0-10 V)	white
3	0 V	blue
4	Out 1 (PNP; NPN)	black

Analoge output signals reprogrammable



Basic dimensions

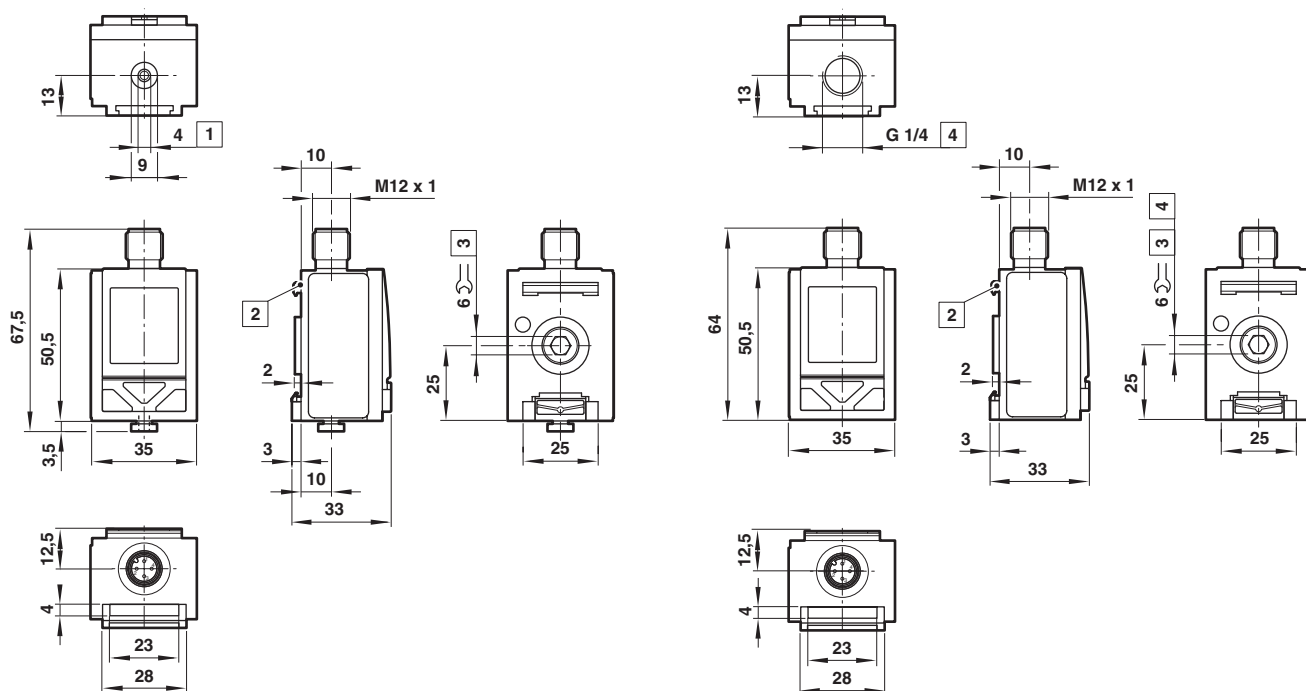

1 Integrated PNEUFIT push-in fitting

2 Wall clip for DIN panel DIN EN 60715 (35 x 7,5; 35 x 15)

3 Maximum torque for plug: 1,0 Nm \pm 0,1

4 Do not use connection nipples with conical threading! Only use connection nipples with axial sealing on the outer flange with a maximum screw-in depth of 9 mm with maximum torque of 2,0 Nm \pm 0,5.

Accessories

Wall clip

Material: plastic

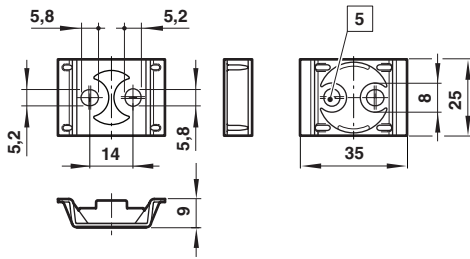

5 Bolts conforming to DIN EN ISO4762 (M5 x 20) included in scope of supply

Front frame for panel mounting

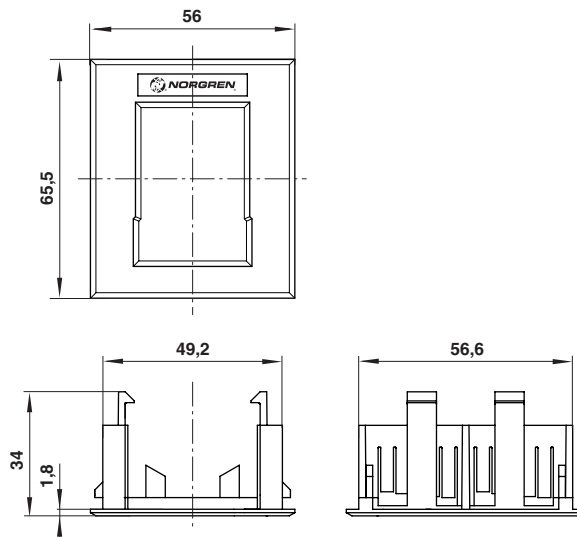

Panel hole

Panel thickness: 1,5 to 3 mm

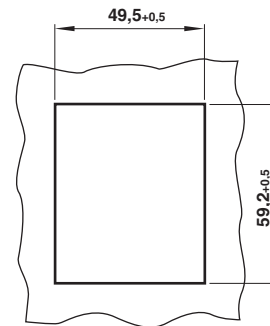

Warning

These products are intended for use in industrial compressed air systems only. Do not use these products where pressures and temperatures can exceed those listed under 'Technical features'.

Before using these products with fluids other than those specified, for non-industrial applications, life-support systems, or other applications not within published specifications, consult NORGREN.

Through misuse, age, or malfunction, components used in fluid power systems can fail in various modes.

The system designer is warned to consider the failure modes of all component parts used in fluid power systems and to provide adequate safeguards to prevent personal injury or damage to equipment in the event of such failure.

System designers must provide a warning to end users in the system instructional manual if protection against a failure mode cannot be adequately provided.

System designers and end users are cautioned to review specific warnings found in instruction sheets packed and shipped with these products.