

HAMEG

Instruments

MANUAL

Spectrum Analyzer HM 5005 / 5006

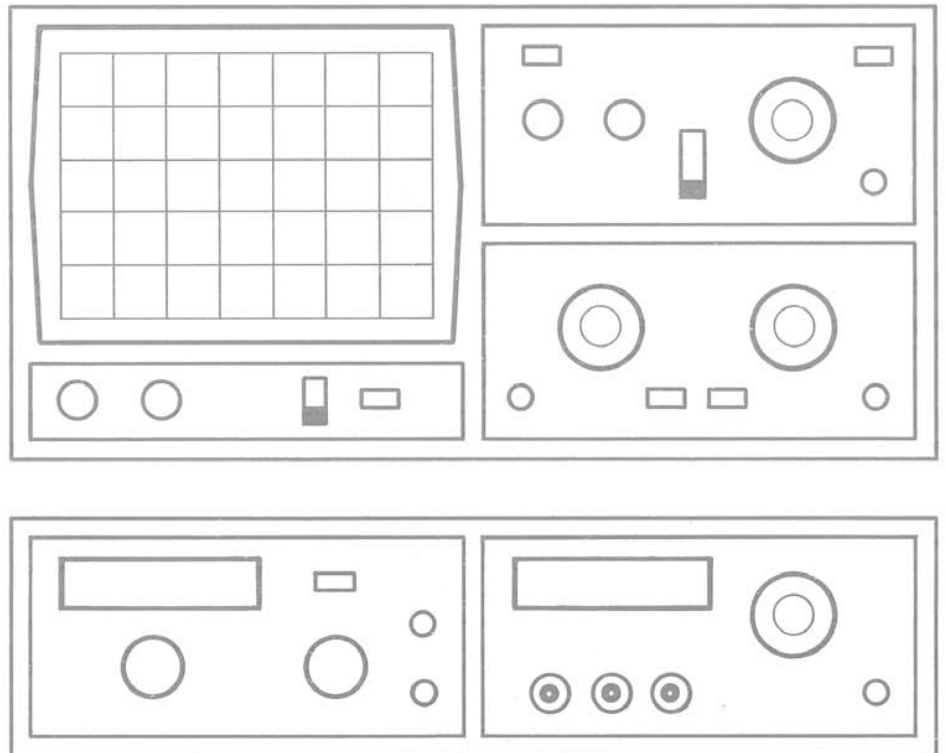

**Datasheet
with technical details**

**Spectrum Analyzer
HM 5005 / 5006**

Operating Instructions

General Information	M 1
Use of tilt handle	M 1
Safety	M 1
Operating conditions	M 2
Warranty	M 2
Maintenance	M 2
Switching over the mains / line voltage	M 2
Introduction	M 3
Operating Instructions	M 3
Elements of Operation	M 3
Vertical Calibration	M 5
Horizontal Calibration	M 6
Introduction to spectrum analysis	M 6
Types of Spectrum Analyzers	M 7

Spectrum Analyzer Requirements

Frequency Measurements	M 7
Resolution	M 8
Sensitivity	M 8
Video Filtering	M 8
Spectrum Analyzer Sensitivity	M 8
Frequency Response	M 9
Tracking Generators	M 9
EMI applications using the Spectrum Analyzer ..	M10

Front Panel Elements

Folder with Front View	M11
-------------------------------------	------------

Block Diagram	B 1
----------------------------	------------

Specifications

Frequency

Frequency range: 0.5MHz to 500MHz (-3dB)
Center frequency display accuracy: $\pm 100\text{kHz}$
Marker accuracy: $\pm(0.1\% \text{ span} + 100\text{kHz})$
Frequency display resolution: 100kHz
 (4 digit LED)
Frequency scanwidth: 50kHz/div. to 50MHz/div.
 in 1-2-5 steps and 0Hz/div. (Zero Scan)
Frequency scanwidth accuracy: $\pm 10\%$
Frequency stability: Drift: $< 150\text{kHz} / \text{hour}$
IF Bandwidth (-3dB):
 Resolution: 250kHz and 12.5kHz
 Video-Filter on: 4kHz
Sweep rate: 43Hz

Amplitude

Amplitude range: -100dBm to +10dBm
Screen display range: 80dB (10dB / div.)
Reference level: -27dBm to +13dBm
 (in 10dB steps)
Reference level accuracy: $\pm 2\text{dB}$
Average noise level: -99dBm (12.5kHz RBW)
Second and third harmonic: $< -75\text{dBc}$
Third order intermod.: -70dBc
 (two signals $> 3\text{MHz}$ apart)
Log scale fidelity: $\pm 2\text{dB}$ (without attn.) 250MHz
IF gain: 10dB adjustment range

Input

Input impedance: 50 Ω
Input connector: BNC
Input attenuator: 0 to 40 dB (4 x 10dB steps)
Input attenuator accuracy: $\pm 1\text{dB}$
Maximum input level: +10dBm, $\pm 25V_{DC}$
 (with 0dB attenuation)
 +20dBm
 (with 40dB attenuation)

Tracking Generator

Output level range: -50dBm to +1dBm
 (in 10dB steps and var.)
Output attenuator: 0 to 40dB (4 x 10dB steps)
Output attenuator accuracy: $\pm 1\text{dB}$
Output impedance: 50 Ω (BNC)
Frequency range: 0.1MHz to 500MHz
Frequency response: $\pm 1.5\text{dB}$
Radio Frequency Interference (RFI): $< 20\text{dBc}$

General

Operating temperature: 10° to 50°C
Display: CRT, 6 inch, 8 x 10 div. internal graticule
Trace rotation: Adjustable on front panel
Line voltage: 115V, 230V_{AC} $\pm 10\%$, 50/60Hz
Power consumption: 20W max.
Protective sytem: Safety Class I (IEC 1010-1)
Weight: approx. 7kg
Dimensions:
 125mm (4.9")H x 285mm (11.2")W x 380mm (15")D

Lockable tilt handle
 (19" rackmount optional)

Subject to change without notice

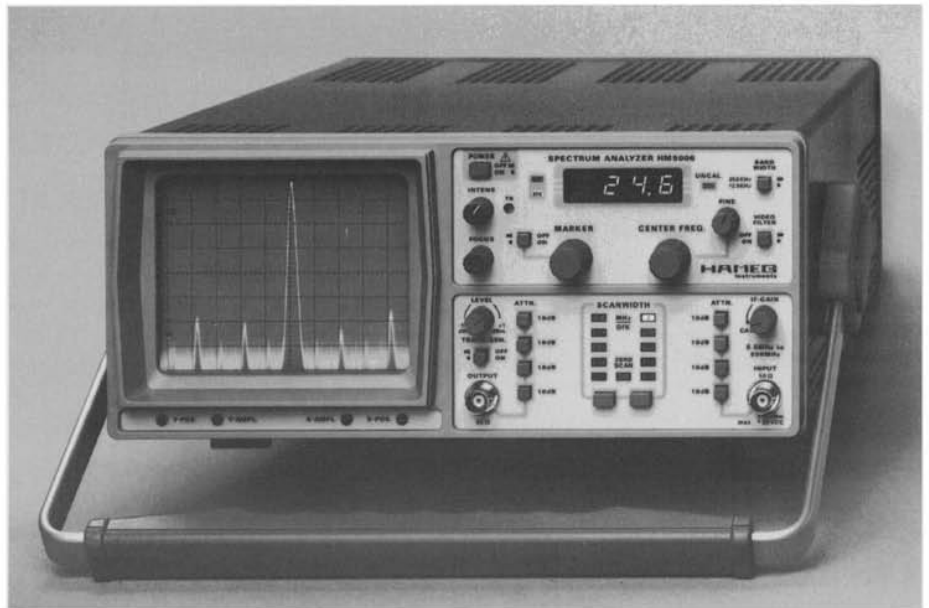

Spectrum Analyzer HM5005 / HM5006

Frequency Range 0.5MHz - 500MHz.
4 Digit Display (Center & Marker Frequency, 0.1MHz resolution)
-100 to +13dBm Amplitude Range, 12.5kHz, 250kHz and Video-Filter

Tracking-Generator (HM5006 only):
Frequency range: 0.1MHz - 500MHz.
Output Voltage: +1dBm to -50dBm (50 Ω).

The **HM5005/HM5006 Spectrum Analyzer** is the ideal instrument for analyzing any kind of signal within the frequency range of **0.5 to 500MHz**. Both models include a **Scanwidth Selector** that can adjust the frequency display width from **50kHz to 50 MHz per division**. Narrow-band signals are easily analyzed by this high resolution feature.

The analyzer can measure low amplitude signals and has a **measurement range of over 110dB**. Including switchable attenuators, a range of **-100dBm to +13dBm** can be measured with 80dB being displayed on the screen at 10dB/division. In **"Zero Scan Mode"** selective amplitude level measurements can be performed, while tuned to fixed frequency.

Both models include a **4 digit numeric LED** readout that can selectively display either the **Center** or **Marker Frequency**. Frequency measurement is accomplished by adjusting a needle-like cursor to the point of interest on the display and reading the 4 digit **Marker Frequency** value.



The model **HM5006** also includes a **Tracking Generator** that permits a **four terminal** measurement that is useful in network and filter passband analysis. The Tracking Generator is a frequency synchronous signal source with a range of **100kHz to 500MHz** that is controlled by the frequency of the spectrum analyzer. The output level is adjustable from **-50dBm to +1dBm** in four **10dB** switchable steps in addition to an **11dB** rotary variable attenuator control.

The **HM5005/5006 Spectrum Analyzer** is extremely low-priced, but still equipped to meet the RF measurement needs of education and industry. With this user friendly instrument **HAMEG out-performs** and **out-prices** its competitors

Accessories Included
 Manual, Power Cord

Optional Accessories
 50 Ω -feedthrough termination HZ22
 Viewing Hood HZ 47
 Near Field Probe Set HZ29
 Carrying Case HZ96-2

Symbols

-  ATTENTION - refer to manual
-  Danger - High voltage
-  Protective ground (earth) terminal

General Information

This spectrum analyzer is easy to operate. The logical arrangement of the controls allows anyone to quickly become familiar with the operation of the instrument, however, experienced users are also advised to read through these instructions so that all functions are understood.

Immediately after unpacking, the instrument should be checked for mechanical damage and loose parts in the interior. If there is transport damage, the supplier must be informed immediately. The instrument must then not be put into operation.

Use of tilt handle

To view the screen from the best angle, there are three different positions (C, D, E) for setting up the instrument. If the instrument is set down on the floor after being carried, the handle automatically remains in the upright carrying position (A).

In order to place the instrument onto a horizontal surface, the handle should be turned to the upper side of the oscilloscope (C). For the D position (10° inclination), the handle should be turned to the opposite direction of the carrying position until it locks in place automatically underneath the instrument. For the E position (20° inclination), the handle should be pulled to release it from the D position and swing backwards until it locks once more.

The handle may also be set to a position for horizontal carrying by turning it to the upper side to lock in the B position. At the same time, the instrument must be lifted, because otherwise the handle will jump back.

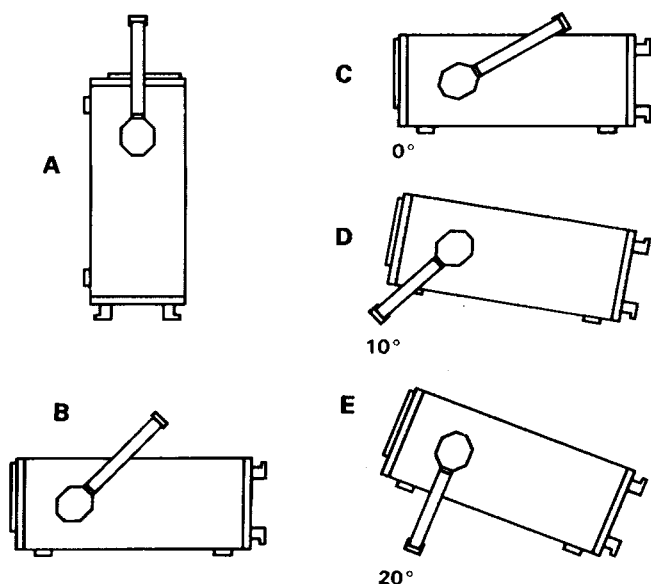

Safety

This instrument has been designed and tested in accordance with **IEC Publication 1010-1, Safety requirements for electrical equipment for measurement, control, and laboratory use**. The CENELEC regulations EN 61010-1 correspond to this standard. It has left the factory in a safe condition. This instruction manual contains important information and warnings which have to be followed by the user to ensure safe operation and to retain the oscilloscope in a safe condition. The case, chassis and all measuring terminals are connected to the protective earth contact of the appliance inlet. The instrument operates according to **Safety Class I** (three-conductor power cord with protective earthing conductor and a plug with earthing contact). The mains/line plug shall only be inserted in a socket outlet provided with a protective earth contact. The protective action must not be negated by the use of an extension cord without a protective conductor.

The mains/line plug should be inserted before connections are made to measuring circuits.

The grounded accessible metal parts (case, sockets, jacks) and the mains/line supply contacts (line/live, neutral) of the instrument have been tested against insulation breakdown with 2200V DC.

Under certain conditions, 50Hz or 60Hz hum voltages can occur in the measuring circuit due to the interconnection with other mains/line powered equipment or instruments. This can be avoided by using an isolation transformer (Safety Class II) between the mains/line outlet and the power plug of the device being investigated.

Most cathode-ray tubes develop X-rays. However, **the dose equivalent rate falls far below the maximum permissible value of 36pA/kg (0.5mR/h)**.

Whenever it is likely that protection has been impaired, the instrument shall be made inoperative and be secured against any unintended operation. The protection is likely to be impaired if, for example, the instrument

- shows visible damage,
- fails to perform the intended measurements,
- has been subjected to prolonged storage under unfavourable conditions (e.g. in the open or in moist environments),
- has been subject to severe transport stress (e.g. in poor packaging).

Operating conditions

The instrument has been designed for indoor use. The permissible ambient temperature range during operation is +10°C (+50°F) ... +40°C (+104°F). It may occasionally be subjected to temperatures between +10°C (+50°F) and -10°C (+14°F) without degrading its safety. The permissible ambient temperature range for storage or transportation is -40°C (-40°F) ... +70°C (+158°F).

The maximum operating altitude is up to 2200m (non-operating 15000m). The maximum relative humidity is up to 80%.

If condensed water exists in the instrument it should be acclimatized before switching on. In some cases (e.g. extremely cold spectrum analyzer) two hours should be allowed before the instrument is put into operation. The instrument should be kept in a clean and dry room and must not be operated in explosive, corrosive, dusty, or moist environments. The spectrum analyzer can be operated in any position, but the convection cooling must not be impaired. For continuous operation the instrument should be used in the horizontal position, preferably tilted upwards, resting on the tilt handle.

The specifications stating tolerances are only valid if the instrument has warmed up for 30 minutes at an ambient temperature between +15°C (+59°F) and +30°C (+86°F). Values without tolerances are typical for an average instrument.

Warranty

HAMEG warrants to its Customers that the products it manufactures and sells will be free from defects in materials and workmanship for a **period of 2 years**. This warranty shall not apply to any defect, failure or damage caused by improper use or inadequate maintenance and care. HAMEG shall not be obliged to provide service under this warranty to repair damage resulting from attempts by personnel other than HAMEG representatives to install, repair, service or modify these products.

In order to obtain service under this warranty, Customers must contact and notify the distributor who has sold the product.

Each instrument is subjected to a quality test with 10 hour burn-in before leaving the production. Practically all early failures are detected by this method. In the case of shipments by post, rail or carrier it is recommended that the original packing is carefully preserved. Transport damages and damage due to gross negligence are not covered by the guarantee.

In the case of a complaint, a label should be attached to the housing of the instrument which describes briefly the faults observed. If at the same time the name and telephone

number (dialing code and telephone or direct number or department designation) is stated for possible queries, this helps towards speeding up the processing of guarantee claims.

Maintenance

Various important properties of the spectrum analyzer should be carefully checked at certain intervals. Only in this way is it largely certain that all signals are displayed with the accuracy on which the technical data are based..

The exterior of the instrument should be cleaned regularly with a dusting brush. Dirt which is difficult to remove on the casing and handle, the plastic and aluminium parts, can be removed with a moistened cloth (99% water + 1% mild detergent). Spirit or washing benzine (petroleum ether) can be used to remove greasy dirt. The screen may be cleaned with water or washing benzine (but not with spirit (alcohol) or solvents), it must then be wiped with a dry clean lint-free cloth. Under no circumstances may the cleaning fluid get into the instrument. The use of other cleaning agents can attack the plastic and paint surfaces.

Switching over the mains / line voltage

The spectrum analyzer operates on mains/line voltages of 115V AC and 230V AC. The voltage selection switch is located on the rear of the instrument and displays the selected voltage. The correct voltage can be selected using a small screwdriver.

Remove the power cable from the power connector prior to making any changes to the voltage setting. The fuses must also be replaced with the appropriate value (see table below) prior to connecting the power cable. Both fuses are externally accessible by removing the fuse cover located above the 3-pole power connector.

The fuseholder can be released by pressing its plastic retainers with the aid of a small screwdriver. The retainers are located on the right and left side of the holder and must be pressed towards the center. The fuse(s) can then be replaced and pressed in until locked on both sides.

Use of patched fuses or short-circuiting of the fuseholder is not permissible; HAMEG assumes no liability whatsoever for any damage caused as a result, and all warranty claims become null and void.

Fuse type:

Size **5 x 20 mm**; 250-Volt AC; must meet IEC specification 127, Sheet III (or DIN 41 662 or DIN 41 571, sheet 3).

Time characteristic: **time-lag**

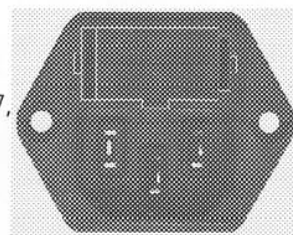

Line voltage **115V** ~ ±10%: Fuse rating: **T 315mA**
Line voltage **230V** ~ ±10%: Fuse rating: **T 160mA**

Introduction

Both instruments HM5005 and HM5006 are spectrum analyzers. The HM5006 also contains a tracking generator. The basic functionality of these two instruments is detailed below.

The spectrum analyzer permits the detection of spectrum components of electrical signals in the frequency range of 0.5 to 500MHz. The detected signal and its content(s) have to be repetitive. In contrast to an oscilloscope operated in Yt mode, where the amplitudes are displayed on the time axis, the spectrum analyzer displays amplitudes on the frequency axis (Yf). The individual spectrum components of "a signal" become visible on a spectrum analyzer. The oscilloscope would display that signal as one resulting waveform.

The spectrum analyzer works according to the triple superhet receiver principle. The signal to be measured ($f_{in} = 0.5\text{MHz}$ to 500MHz) is applied to the 1st mixer where it is mixed with the signal of a variable voltage controlled oscillator (f_{LO} 610MHz - 1110MHz). This oscillator is called the 1st LO (local oscillator). The difference between the oscillator and the input frequency ($f_{LO} - f_{in} = 1\text{st IF}$) is the first intermediate frequency, which passes through a waveband filter tuned to a center frequency of 609.5MHz. It then enters an amplifier, and this is followed by two additional mixing stages, oscillators and amplifiers. The second IF is 29.5MHz and the third is 2.9MHz. In the third IF stage, the signal can be selectively transferred through a filter with 250kHz or 12.5kHz bandwidth before arriving at an AM demodulator. The logarithmic output (video signal) is transferred directly, or via a low pass filter to another amplifier. This amplifier output is connected to the Y deflection plates of the CRT.

The X deflection is performed with a ramp generator voltage. This voltage can also be superimposed on a dc voltage which allows for the control of 1st LO. The spectrum analyzer scans a frequency range depending on the ramp height. This span is determined by the scanwidth setting. In ZERO SCAN mode only the direct voltage controls the 1st LO.

The HM5006 also includes a tracking generator. This generator generates sine wave voltages within the frequency range of 0.1 to 500MHz. The tracking generator frequency is determined by the first oscillator (1st LO) of the spectrum analyzer section. Spectrum analyzer and tracking generator are frequency synchronized.

Operating Instructions

It is very important to read the paragraph "**Safety**" including the instructions prior to operating the HM5005/HM5006.

No special knowledge is necessary for the operation of the HM5005/HM5006. The straightforward front panel layout and the limitation to basic functions guarantee efficient operation directly from switch on. Never the less, to ensure the optimum operation of the instrument, some basic instructions need to be followed.

The most sensitive component of the HM5005/HM5006 is the input section of the spectrum analyzer. It consists of the signal attenuator and the first mixer. Without input attenuation, the voltage at the input must not exceed +10dBm (0.7Vrms) AC or ± 25 volt DC. With a maximum input attenuation of 40dB the AC voltage must not exceed +20dBm. **These limiting values must not be exceeded** or the input attenuator and/or the first mixer will be destroyed.

Prior to examining unidentified signals, the presence of unacceptable high voltages has to be checked. It is also recommended to start measuring with the highest possible attenuation and a maximum frequency range (500MHz). The user should also consider the possibility of excessively high signal amplitudes outside the covered frequency range, although not displayed (e.g. 600MHz).

The frequency range of 0Hz to 500kHz is not covered by the HM5005/HM5006 spectrum analyzer. Spectral lines within this range would be displayed with incorrect amplitude.

A particularly high intensity adjustment is not necessary as "hidden" signals may be masked, the phosphor on the CRT being loaded more where the noise is always displayed. On the contrary, such signals will be harder to detect due to the increasing beam width, even with optimized focus setting. The way signals are displayed on the spectrum analyzer typically allows for any signal to be recognized easily, even with low intensity.

Due to the frequency conversion principle, a spectral line is visible at 0Hz. This line appears when the 1st LO frequency passes the IF amplifiers and filters. The level of this spectral line is different in each instrument. A deviation from the full screen does not indicate a malfunctioning instrument.

Elements of Operation

The fold-out picture of the instrument's front plate after these instructions, contains numbers referred to below: The front plate is subdivided into three fields. Following are detailed descriptions of the control functions located on the **top right** next to the screen.

(1) POWER:

The power button with ON and OFF symbols. If power is switched to ON position, noise will be visible on the screen after approximately 10 seconds.

(2) INTENS:

This knob is used to adjust the intensity of the signal.

(3) FOCUS:

This control is for optimum sharpness adjustment.

(4) TR (Trace Rotation):

In spite of Mumetal-shielding of the CRT, effects of the earth's magnetic field on the horizontal trace position cannot be completely avoided. A potentiometer accessible through an opening can be used for correction. Unimportant pincushion distortions are unavoidable and cannot be corrected.

(5) CF (CENTER FREQUENCY):

This LED is lit when the digital display shows the center frequency. The center frequency is the frequency which is displayed in the center (25) of the CRT X-axis.

(6) MK:

This LED is lit when the Marker pushbutton is in the **ON** position. The digital display then shows the marker frequency. The frequency of spectral lines not displayed on a vertical graticule line can be determined by this function.

(7) MARKER - ON/OFF:

If the MARKER pushbutton is set to the **OFF** position, the **CF** indicator is lit and the display shows the center frequency. When the switch is in the **ON** position, **MK** is lit and the display shows the marker frequency. The marker is shown on the screen as a vertical needle. The marker frequency is adjustable with the **MARKER** knob and can be aligned with a spectral line. **Before any LEVEL reading can be obtained, the marker must be switched OFF.**

(8) CENTER FREQ. - FINE:

Both rotary knobs are used for center frequency determination.

The **FINE** adjustment function is self explanatory. The center frequency is displayed at the horizontal center (25) of the screen.

(9) UNCAL.:

The blinking of this LED signifies incorrectly displayed amplitude values. This may occur when the scanned frequency range (**SCANWIDTH**) is too large when compared to the IF bandwidth (12.5kHz), and/or the video filter bandwidth (4kHz). Measurements can then either be taken without a filter (bandwidth, video), or the scanwidth has to be decreased (scanwidth). The **UNCAL.** indicator will also blink when the **IF GAIN** knob is not in the **CAL.** position.

(10) BANDWIDTH:

Selects between 250kHz and 12.5kHz IF bandwidth. If a bandwidth of 12.5kHz is selected, the noise level decreases and the selectivity is improved. Spectral lines which are

relatively close together can be distinguished. As the small signal transient response requires a longer time this causes incorrect amplitude values if the scanwidth is set at too wide a frequency span. The **UNCAL.** indicator will signify this condition.

(11) VIDEO FILTER:

The video filter may be used for noise reduction. It enables small level spectral lines to become visible which normally would be within or just above the medium noise level. The filter bandwidth is 4kHz. Again it has to be noted that incorrect amplitude values will be displayed if the scanwidth setting is too high and the video filter active (ON). Such conditions are indicated by the **UNCAL.** LED.

Front plate bottom right section.

(12) INPUT:

The BNC 50Ω input of the spectrum analyzer. Without input attenuation the maximum permissible input voltages of ±25V DC and +10dBm AC must not be exceeded. With the maximum input attenuation of 40dB the maximum input voltage is +20dBm.

The maximum dynamic range of the instrument is 70dB. Higher input voltages exceeding the reference level cause signal compression and intermodulation. Those effects will lead to erroneous displays. If the input level exceeds the reference level, the input level attenuation must be increased.

(13) ATTN.:

The Input Attenuator consists of four equal 10dB attenuators, reducing the signal height before entering the 1st mixer. Each attenuator is active if the push button is depressed.

The correlation of selected attenuation, reference level and baseline level (noise level) is demonstrated on the following chart:

Attenuation	Reference level		Base line
0dB	-27dBm	10mV	-107dBm
10dB	-17dBm	31.6mV	-97dBm
20dB	- 7dBm	0.1V	-87dBm
30dB	+ 3dBm	316mV	-77dBm
40dB	+13dBm	1V	-67dBm

The reference level is represented by the highest horizontal graticule line (26). The lowest horizontal graticule line indicates the baseline (24). The vertical graticule is subdivided in 10dB steps.

As previously pointed out, the maximum permissible input voltages may not be exceeded. This is extremely important because it is possible that the spectrum analyzer

will only show a partial spectrum of currently applied signals. Consequently, input signals might be applied with excessive levels outside the displayed frequency range leading to the destruction of the input attenuator and/or the 1st mixing stage. Also refer to **INPUT**.

The highest attenuation (4 x 10dB) and the highest usable frequency range (scanwidth setting 50MHz/DIV.) should be selected prior to connecting any signal to the HM5005/HM5006 input. This permits the detection of any spectral lines which are within the maximum measurable and displayable frequency range, if the center frequency is set to 250MHz. If the baseline tends to move upwards when the attenuation is decreased, it may indicate spectral lines outside the maximum displayable frequency range (i.e. 600MHz) with excessive amplitude.

(14) IF-GAIN:

This knob allows for the continuous adjustment of the intermediate frequency amplification (IF-GAIN). The amplification is calibrated at full left position. It increases to approx. 10dB when rotated to the right, however, without being calibrated.

(15) SCANWIDTH:

The SCANWIDTH field contains indicators which highlight the appropriate frequency range per graticule division. The range can be increased in steps with the right hand button, and decreased with the left. Switching is accomplished in 1-2-5 steps from 50kHz/div. to 50MHz/div.

The width of the scan range is displayed in MHz/div. and refers to each horizontal division on the graticule. The center frequency is indicated by the vertical graticule line at the horizontal. If the center frequency and the scanwidth setting are correct, the X axis has a length of 10 divisions. With scanwidth settings below 50MHz, only a part of the total frequency range is displayed in expanded mode.

When the SCANWIDTH is set to 50MHz/div, if the center frequency is set to 250MHz, the frequency extends to the right by 50MHz per division, ending at 500MHz (250MHz+(5x50MHz)). The frequency decreases to the left in the same way. In this case the left graticule edge corresponds to 0Hz.

With these settings, a spectral line is visible which is referred to as "**Zero Frequency Point**". It is the 1st LO (oscillator) which becomes visible when its frequency passes the first IF filter. This occurs when the center frequency is low relative to the scanwidth range selected. The "Zero Frequency Point" is different in each instrument and therefore cannot be used as a reference level. Spectral lines displayed left of the "Zero Frequency Point" are so called image frequencies.

In the **ZERO SCAN** mode the spectrum analyzer operates as a receiver with selectable bandwidth. The frequency is

selected via the **CENTER FREQ.** knob. Spectral line(s) passing the IF filter cause a level display (selective voltmeter function).

(16) TRACK.GEN. (HM5006 only):

The Tracking Generator is activated if the push button is depressed (ON). In this case, a sine signal can be obtained from the **OUTPUT** BNC socket with a frequency determined by the spectrum analyzer. In ZERO SCAN mode the center frequency appears at the output.

(17) OUTPUT (HM5006 only):

50Ω BNC socket of the tracking generator. The output level can be determined from +1dBm to -50dBm.

(18) LEVEL (HM5006 only):

The output level of the Tracking Generator can be continuously adjusted with this knob by 11dBm (-10dBm to +1dBm).

(19) ATTN. (HM5006 only):

Output level attenuator with four 10dB attenuators which allows the signal to be reduced prior to reaching the **OUTPUT** socket.

All four attenuators are equal and can be activated by depressing the respective push button. Therefore it is immaterial which attenuators are used to reach e.g. a 20dB attenuation.

Section underneath the screen.

The following controls are located below the screen:

(20) Y-POS. (Y-position), **(21) Y-AMPL.** (Y-amplitude), **(22) X-AMPL.** (X-amplitude) and **(23) X-POS.** (X-position).

IMPORTANT: These controls are designated for the accuracy of amplitude and frequency and do not require adjustment under normal circumstances. A very accurate RF Generator (e.g. HAMEG HM8133) is essential for any adjustments of these controls.

Vertical Calibration

Prior to calibration, ensure that all input attenuators **(13)** are deactivated and that the **IF-GAIN** knob **(14)** is set to **CAL.** position. The HM5005/5006 must be in operation for at least 60 minutes prior to the calibration. Switch **VIDEO FILTER (11)** to **OFF** position, set **BANDWIDTH (10)** to 250kHz, and **SCANWIDTH (15)** to 2MHz/div.

Connect RF signal of -27dBm (10mV) to the spectrum analyzer input **(12)**. The frequency of this signal should be between 2MHz and 250MHz. Set the center frequency to the signal frequency.

A: A single spectral line (–27dBm) appears on the screen if a sufficiently low-distortion signal source is present. The spectral line maximum is now adjusted with the **Y-POS.** control **(20)** and placed at the top graticule line **(26)** of the screen. All input attenuators have to be deactivated.

B: Next, the generator signal must be switched back and forth between –27dBm and –77dBm, and the **Y-AMPL.** control **(21)** adjusted so that the spectral line peak changes by 5 divisions in the vertical direction. If this results in a change of the Y-position, the calibration outlined under **A** has to be repeated.

The calibrations **A** and **B** have to be repeated until an ideal adjustment is achieved.

Finally, the operation of the input attenuators **(13)** can be tested at a level of –27dBm. The spectral line visible on the screen can be reduced in 4 steps of 10dB each by activating the attenuators incorporated in the spectrum analyzer. Each 10 dB step corresponds to one graticule division on the screen. The tolerance may not exceed ± 1 dB in all attenuation positions.

Horizontal Calibration

Prior to calibration ensure that all input attenuators **(13)** are deactivated and the **IF-GAIN** knob **(14)** is in **CAL.** position. The HM5005/5006 must be in operation for at least 60 minutes prior to calibration. The **VIDEO FILTER** push button **(11)** must be in **OFF** position, the **BANDWIDTH (10)** set to 250kHz, and **SCANWIDTH (15)** set to 50MHz/div. After the center frequency is set to 250MHz, a generator signal must be applied to the input. The output level should be between 40 and 50 dB above the noise.

C: Set generator frequency to **250MHz**. Adjust the peak of the 250MHz spectral line to the horizontal screen center **(25)** using the **X-POS.** control **(23)**.

D: Set the generator frequency to **50MHz**. If the 50MHz spectral line is not on the graticule line **(27)** it should be aligned using the **X-AMPL.** control **(22)**. Then the calibration as described under C should be verified and corrected if necessary.

The calibrations **C** and **D** should be repeated until optimum adjustment is achieved.

Introduction to spectrum analysis

The analysis of electrical signals is a fundamental problem for many engineers and scientists. Even if the immediate problem is not electrical, the basic parameters of interest are often changed into electrical signals by means of transducers. Common transducers include accelerometers and load cells in mechanical work, EEG electrodes and blood pressure probes in biology and medicine, and pH

and conductivity probes in chemistry. The rewards for transforming physical parameters to electrical signals are great, as many instruments are available for the analysis of electrical signals in the time and frequency domains.

The traditional way of observing electrical signals is to view them in the time domain using an oscilloscope. The time domain is used to recover relative timing and phase information which is needed to characterize electric circuit behavior. However, not all circuits can be uniquely characterized from just time domain information. Circuit elements such as amplifiers, oscillators, mixers, modulators, detectors and filters are best characterized by their frequency response information. This frequency information is best obtained by viewing electrical signals in the frequency domain. To display the frequency domain requires a device that can discriminate between frequencies while measuring the power level at each. One instrument which displays the frequency domain is the spectrum analyzer. It graphically displays voltage or power as a function of frequency on a CRT (cathode ray tube).

In the time domain, all frequency components of a signal are seen summed together. In the frequency domain, complex signals (i.e. signals composed of more than one frequency) are separated into their frequency components, and the power level at each frequency is displayed. The frequency domain is a graphical representation of signal amplitude as a function of frequency.

The frequency domain contains information not found in the time domain and therefore, the spectrum analyzer has certain advantages compared with an oscilloscope.

The analyzer is more sensitive to low level distortion than a scope. Sine waves may look good in the time domain, but in the frequency domain, harmonic distortion can be seen.

The sensitivity and wide dynamic range of the spectrum analyzer is useful for measuring low-level modulation. It can be used to measure AM, FM and pulsed RF. The analyzer can be used to measure carrier frequency, modulation frequency, modulation level, and modulation distortion.

Frequency conversion devices can be easily characterized. Such parameters as conversion loss, isolation, and distortion are readily determined from the display.

The spectrum analyzer can be used to measure long and short term stability. Parameters such as noise sidebands on an oscillator, residual FM of a source and frequency drift during warm-up can be measured using the spectrum analyzers calibrated scans.

The swept frequency responses of a filter or amplifier are examples of swept frequency measurements possible with a spectrum analyzer. These measurements are simplified by using a tracking generator.

Types of Spectrum Analyzers

There are two basic types of spectrum analyzers, swept-tuned and real-time analyzers. The swept-tuned analyzers are tuned by electrically sweeping them over their frequency range. Therefore, the frequency components of a spectrum are sampled sequentially in time. This enables periodic and random signals to be displayed, but makes it impossible to display transient responses. Real-time analyzers, on the other hand, simultaneously display the amplitude of all signals in the frequency range of the analyzer; hence the name real-time. This preserves the time dependency between signals which permits phase information to be displayed. Real-time analyzers are capable of displaying transient responses as well as periodic and random signals.

The swept-tuned analyzers are usually of the trf (tuned radio frequency) or superheterodyne type. A trf analyzer consists of a bandpass filter whose center frequency is tunable over a desired frequency range, a detector to produce vertical deflection on a CRT, and a horizontal scan generator used to synchronize the tuned frequency to the CRT horizontal deflection. It is a simple, inexpensive analyzer with wide frequency coverage, but lacks resolution and sensitivity. Because trf analyzers have a swept filter they are limited in sweep width depending on the frequency range (usually one decade or less). The resolution is determined by the filter bandwidth, and since tunable filters don't usually have constant bandwidth, it is dependent on frequency.

The most common type of spectrum analyzer differs from the trf spectrum analyzers in that the spectrum is swept through a fixed bandpass filter instead of sweeping the filter through the spectrum.

The analyzer is basically a narrowband receiver which is electronically tuned in frequency by applying a saw-tooth voltage to the frequency control element of a voltage tuned local oscillator. This same saw-tooth voltage is simultaneously applied to the horizontal deflection plates of the CRT. The output from the receiver is synchronously applied to the vertical deflection plates of the CRT and a plot of amplitude versus frequency is displayed.

The analyzer is tuned through its frequency range by varying the voltage on the LO (local oscillator). The LO frequency is mixed with the input signal to produce an IF (intermediate frequency) which can be detected and displayed. When the frequency difference between the input signal and the LO frequency is equal to the IF frequency, then there is a response on the analyzer. The advantages of the superheterodyne technique are considerable. It obtains high sensitivity through the use of IF amplifiers, and many decades in frequency can be tuned. Also, the resolution can be varied by changing the bandwidth of the IF filters. However, the superheterodyne analyzer is not real-time and sweep rates must be consistent with the IF filter time constant.

A peak at the left edge of the CRT is sometimes called the "zero frequency indicator" or "local oscillator feedthrough". It occurs when the analyzer is tuned to zero frequency, and the local oscillator passes directly through IF creating a peak on the CRT even when no input signal is present. (For zero frequency tuning, $F_{LO}=F_{IF}$). This effectively limits the lower tuning limit.

Spectrum Analyzer Requirements

To accurately display the frequency and amplitude of a signal on a spectrum analyzer, the analyzer itself must be properly calibrated. A spectrum analyzer properly designed for accurate frequency and amplitude measurements has to satisfy many requirements:

1. Wide tuning range
2. Wide frequency display range
3. Stability
4. Resolution
5. Flat frequency response
6. High sensitivity
7. Low internal distortion
8. Linear and Logarithmic display modes (voltage and dB)

Frequency Measurements

The frequency scale can be scanned in three different modes full, per division, and zero scan. The full scan mode is used to locate signals because the widest frequency ranges are displayed in this mode. (Not all spectrum analyzers offer this mode).

The per division mode is used to zoom-in on a particular signal. In per division, the center frequency of the display is set by the Tuning control and the scale factor is set by the Frequency Span or Scan Width control.

In the zero scan mode, the analyzer acts as a fixed-tuned receiver with selectable bandwidths.

Absolute frequency measurements are usually made from the spectrum analyzer tuning dial. Relative frequency measurements require a linear frequency scan. By measuring the relative separation of two signals on the display, the frequency difference can be determined.

It is important that the spectrum analyzer be more stable than the signals being measured. The stability of the analyzer depends on the frequency stability of its local oscillators. Stability is usually characterized as either short term or long term. Residual FM is a measure of the short term stability which is usually specified in Hz peak-to-peak. Short term stability is also characterized by noise sidebands which are a measure of the analyzers spectral

purity. Noise sidebands are specified in terms of dB down and Hz away from a carrier in a specific bandwidth. Long term stability is characterized by the frequency drift of the analyzers LOs. Frequency drift is a measure of how much the frequency changes during a specified time (i.e., Hz/min. or Hz/hr).

Resolution

Before the frequency of a signal can be measured on a spectrum analyzer it must first be resolved. Resolving a signal means distinguishing it from its nearest neighbours. The resolution of a spectrum analyzer is determined by its IF bandwidth. The IF bandwidth is usually the 3dB bandwidth of the IF filter. The ratio of the 60dB bandwidth (in Hz) to the 3dB bandwidth (in Hz) is known as the shape factor of the filter. The smaller the shape factor, the greater is the analyzers capability to resolve closely spaced signals of unequal amplitude. If the shape factor of a filter is 15:1, then two signals whose amplitudes differ by 60dB must differ in frequency by 7.5 times the IF bandwidth before they can be distinguished separately. Otherwise, they will appear as one signal on the spectrum analyzer display.

The ability of a spectrum analyzer to resolve closely spaced signals of unequal amplitude is not a function of the IF filter shape factor only. Noise sidebands can also reduce the resolution. They appear above the skirt of the IF filter and reduce the offband rejection of the filter. This limits the resolution when measuring signals of unequal amplitude.

The resolution of the spectrum analyzer is limited by its narrowest IF bandwidth. For example, if the narrowest bandwidth is 10kHz then the nearest any two signals can be and still be resolved is 10kHz. This is because the analyzer traces out its own IF band-pass shape as it sweeps through a CW signal. Since the resolution of the analyzer is limited by bandwidth, it seems that by reducing the IF bandwidth infinitely, infinite resolution will be achieved. The fallacy here is that the usable IF bandwidth is limited by the stability (residual FM) of the analyzer. If the internal frequency deviation of the analyzer is 10kHz, then the narrowest bandwidth that can be used to distinguish a single input signal is 10kHz. Any narrower IF-filter will result in more than one response or an intermittent response for a single input frequency. A practical limitation exists on the IF bandwidth as well, since narrow filters have long time constants and would require excessive scan time.

Sensitivity

Sensitivity is a measure of the analyzers' ability to detect small signals. The maximum sensitivity of an analyzer is limited by its internally generated noise. This noise is basically of two types: thermal (or Johnson) and nonthermal noise. Thermal noise power can be expressed as:

$$P_N = kTxB$$

where: P_N = Noise power in watts
 k = Boltzmanns Constant (1.38×10^{-23} Joule/K)
 T = absolute temperature, K
 B = bandwidth of system in Hertz

As seen from this equation, the noise level is directly proportional to bandwidth. Therefore, a decade decrease in bandwidth results in a 10dB decrease in noise level and consequently 10dB better sensitivity. Nonthermal noise accounts for all noise produced within the analyzer that is not temperature dependent. Spurious emissions due to nonlinearities of active elements, impedance mismatch, etc. are sources of nonthermal noise. A figure of merit, or noise figure, is usually assigned to this nonthermal noise which when added to the thermal noise gives the total noise of the analyzer system. This system noise which is measured on the CRT, determines the maximum sensitivity of the spectrum analyzer. Because noise level changes with bandwidth, it is important, when comparing the sensitivity of two analyzers, to compare sensitivity specifications for equal bandwidths.

A spectrum analyzer sweeps over a wide frequency range, but is really a narrow band instrument. All of the signals that appear in the frequency range of the analyzer are converted to a single IF frequency which must pass through an IF filter; the detector sees only this noise at any time. Therefore, the noise displayed on the analyzer is only that which is contained in the IF passband. When measuring discrete signals, maximum sensitivity is obtained by using the narrowest IF bandwidth.

Video Filtering

Measuring small signals can be difficult when they are approximately the same amplitude as the average internal noise level of the analyzer. To facilitate the measurement, it is best to use video filtering. A video filter is a post-detection low pass filter which averages the internal noise of the analyzer. When the noise is averaged, the input signal may be seen.

If the resolution bandwidth is very narrow for the span, the video filter should not be selected, as this will not allow the amplitude of the analyzed signals to reach full amplitude due to its video bandwidth limiting property.

Spectrum Analyzer Sensitivity

Specifying sensitivity on a spectrum analyzer is somewhat arbitrary. One way of specifying sensitivity is to define it as the signal level when signal power = average noise power.

The analyzer always measures signal plus noise. Therefore, when the input signal is equal to the internal noise level, the signal will appear 3dB above the noise. When the signal power is added to the average noise power, the power level on the CRT is doubled (increased by 3dB) because the signal power=average noise power.

The maximum input level to the spectrum analyzer is the damage level or burn-out level of the input circuit. This is (for the HM5005/5006) +10dBm for the input mixer and +20dBm for the input attenuator. Before reaching the damage level of the analyzer, the analyzer will begin to gain compress the input signal. This gain compression is not considered serious until it reaches 1dB. The maximum input signal level which will always result in less than 1dB gain compression is called the linear input level.

Above 1dB gain compression the analyzer is considered to be operating nonlinearly because the signal amplitude displayed on the CRT is not an accurate measure of the input signal level.

Whenever a signal is applied to the input of the analyzer, distortions are produced within the analyzer itself. Most of these are caused by the non-linear behavior of the input mixer. For the HM5005/5006 these distortions are typically 70dB below the input signal level for signal levels not exceeding -27dBm at the input of the first mixer. To accommodate larger input signal levels, an attenuator is placed in the input circuit before the first mixer. The largest input signal that can be applied, at each setting of the input attenuator, while maintaining the internally generated distortions below a certain level, is called the optimum input level of the analyzer. The signal is attenuated before the first mixer because the input to the mixer must not exceed -27dBm, or the analyzer distortion products may exceed the specified 70dB range. This 70dB distortion-free range is called the spurious-free dynamic range of the analyzer. The display dynamic range is defined as the ratio of the largest signal to the smallest signal that can be displayed simultaneously with no analyzer distortions present.

Dynamic range requires several things then. The display range must be adequate, no spurious or unidentified response can occur, and the sensitivity must be sufficient to eliminate noise from the displayed amplitude range. The maximum dynamic range for a spectrum analyzer can be easily determined from its specifications. First check the distortion spec. For example, this might be "all spurious products 70dB down for -27dBm at the input mixer". Then, determine that adequate sensitivity exists. For example, 70dB down from -27dBm is -97dB. This is the level we must be able to detect, and the bandwidth required for this sensitivity must not be too narrow or it will be useless. Last, the display range must be adequate.

Notice that the spurious-free measurement range can be extended by reducing the level at the input mixer. The only limitation, then, is sensitivity.

To ensure a maximum dynamic range on the CRT display, check to see that the following requirements are satisfied.

1. The largest input signal does not exceed the optimum input level of the analyzer (typically -27dBm with 0dB input attenuation).

2. The peak of the largest input signal rests at the top of the CRT display (reference level).

Frequency Response

The frequency response of an analyzer is the amplitude linearity of the analyzer over its frequency range. If a spectrum analyzer is to display equal amplitudes for input signals of equal amplitude, independent of frequency, then the conversion (power) loss of the input mixer must not depend on frequency. If the voltage from the LO is too large compared to the input signal voltage then the conversion loss of the input mixer is frequency dependent and the frequency response of the system is nonlinear. For accurate amplitude measurements, a spectrum analyzer should be as flat as possible over its frequency range.

Flatness is usually the limiting factor in amplitude accuracy since its extremely difficult to calibrate out. And, since the primary function of the spectrum analyzer is to compare signal levels at different frequencies, a lack of flatness can seriously limit its usefulness.

TRACKING GENERATORS

The tracking generator (HM5006 only) is a special signal source whose RF output frequency tracks (follows) some other signal beyond the tracking generator itself. In conjunction with the spectrum analyzer, the tracking generator produces a signal whose frequency precisely tracks the spectrum analyzer tuning.

The tracking generator frequency precisely tracks the spectrum analyzer tuning since both are effectively tuned by the same VTO. This precision tracking exists in all analyzer scan modes. Thus, in full scan, the tracking generator output is a start-stop sweep, in zero scan the output is simply a CW signal.

The tracking generator signal is generated by synthesizing and mixing two oscillators. One oscillator is part of the tracking generator itself, the other oscillator is the spectrum analyzer 1st LO.

The spectrum analyzer/tracking generator system is used in two configurations: open-loop and closed-loop. In the open-loop configuration, unknown external signals are connected to the spectrum analyzer input and the tracking generator output is connected to a counter. This configuration is used for making selective and sensitive precise measurement of frequency, by tuning to the signal and switching to zero scan.

In the closed-loop configuration, the tracking generator signal is fed into the device under test and the output of the device under test is connected to the analyzer input.

In this configuration, the spectrum-analyzer/tracking-generator becomes a self-contained, complete (source, detector, and display) swept frequency measurement system. An internal leveling loop in the tracking generator ensures a leveled output over the entire frequency range. The specific swept measurements that can be made with this system are frequency response (amplitude vs. frequency), magnitude only reflection coefficient, and return loss. From return loss or reflection coefficient, the SWR can be calculated. Swept phase and group delay measurements cannot be made with this system; however, it does make some unique contributions not made by other swept systems, such as a sweeper/network analyzer, a sweeper/spectrum analyzer, or a sweeper/detector oscilloscope.

Precision tracking means at every instant of time the generator fundamental frequency is in the center of the

analyzer passband, and all generator harmonics, whether they are generated in the analyzer or are produced in the tracking generator itself, are outside the analyzer passband. Thus only the tracking generator fundamental frequency is displayed on the analyzers CRT. Second and third order harmonics and intermodulation products are clearly out of the analyzer tuning and, therefore, they are not seen. Thus, while these distortion products may exist in the measurement set-up, they are completely eliminated from the CRT display.

The 1dB gain compression level is a point of convenience, but it is nonetheless considered the upper limit of the dynamic range. The lower limit, on the other hand, is dictated by the analyzer sensitivity which, as we know, is bandwidth dependent. The narrowest usable bandwidth in turn is limited by the tracking generator residual FM and any tracking drift between the analyzer tuning and the tracking generator signal.

EMI applications using the spectrum analyzer

Radio frequency interference (rfi), electromagnetic interference (emi) and electromagnetic compatibility (emc) are all related terms. They deal with the tendency of electromagnetic equipment to interfere with each other. For applications where test to identify and measure undesired emissions are made, HAMEG offers a set of nearfield sniffer probes (HZ29) and a set of 50Ω attenuators (HZ24).

The HZ29 Probe Set is designed to assist in providing quick identification of signal sources. It can also be used to diagnose emissions from circuit boards, integrated circuits, PC board etch runs, ribbon cables, cover seams and similar emission sources.

Either an oscilloscope or spectrum analyzer may be used as the signal analyzing device. In applications requiring increased sensitivity, use of the preamplifier is recommended.

The basic set includes three loop probes, one ball probe one stub probe an optional preamplifier with a battery charger 220V AC/50-60Hz an extension handle and a custom carrying case. The probe set is designed for nearfield relative readings only. The probes offer different sensitivities and are also capable of emitting signals over a broad frequency range.

The loop probes in the set are selective of magnetic (H) fields and are directional. For each loop probe, H-field sensitivity is relative to loop diameter.

The ball and stub probes in the set are omnidirectional and are designed for identifying electric (E) field signals over a broad frequency range. The stub probe is desensitized for precise E-field source location.

The broadband preamplifier provides amplification of weak signals for input to a signal analyzing device. The unit covers a frequency range of 300Hz to 600MHz with 18dB of flat voltage gain, a noise figure of 6dB and a 1dB compression point of 4dBm output. Internal battery power eliminates erroneous readings due to ground loops or power line noise. The preamplifiers signal distortion is not significant.

Preamplifier

Absolute maximum ratings:

Input Voltage (DC): 60V_{DC}; Input Voltage (AC): 50V_{pp}

Operating Temperature: -55°C to +125°C

Features:

Bandwidth (to 3dB points): 300Hz-600MHz

Gain (normal): 18dB

Noise Figure (Ref. 50Ω): 6dB typical

Saturated Output Power (at F = 100MHz): +7dBm

1dB Gain Compression (at F = 100MHz): +4dBm

Third-Order Intermodulation intercept: +17dBm

Second-Order Intermodulation intercept,

Every Recept: +24dBm

Battery Life (typical): 20 Hours

N cell Alkaline recommended such as:

Duracell #MN9100, Ever Ready #E90, Ray O-Vac #81C

Rechargeable N cell Nickel Cadmium may be used

HM5005

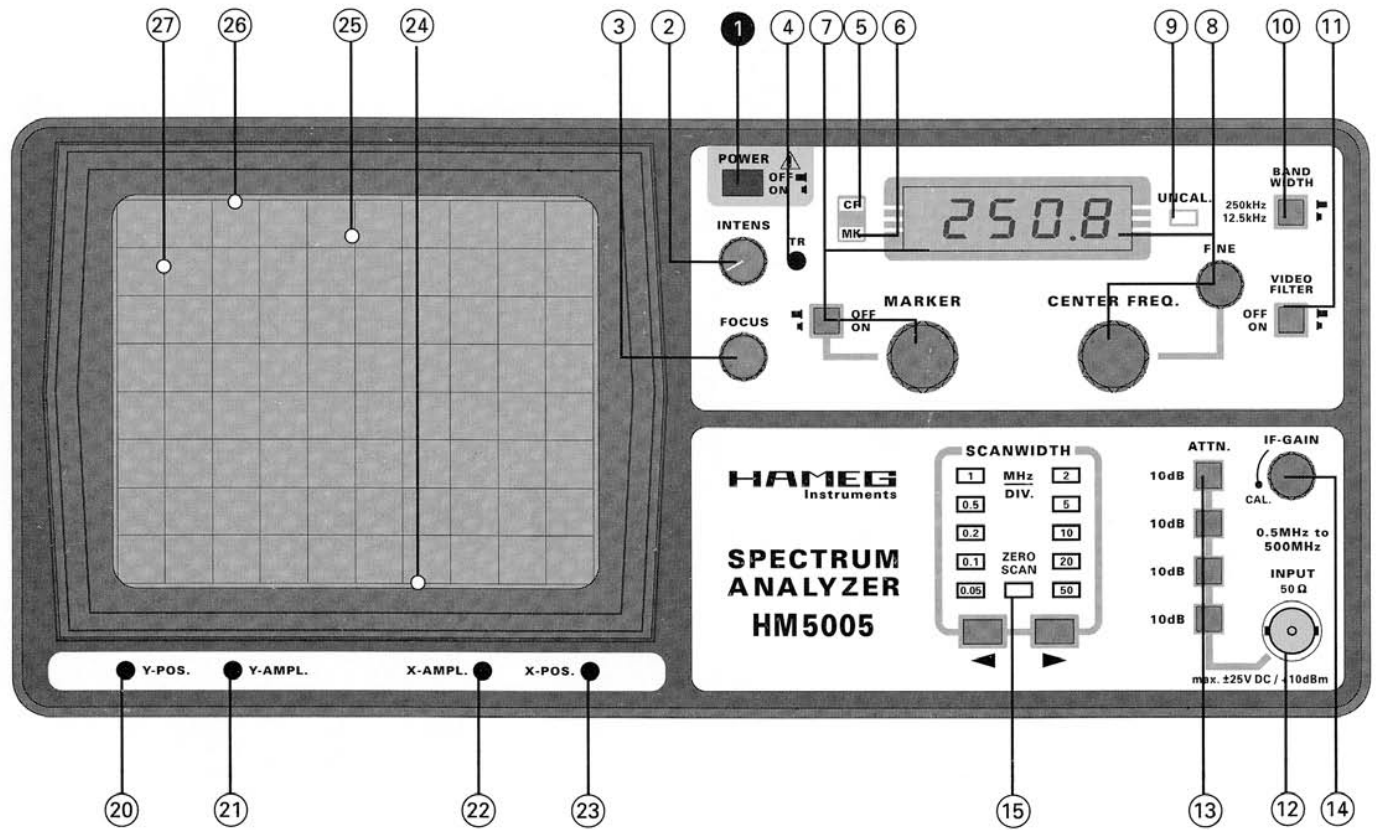

HM5006

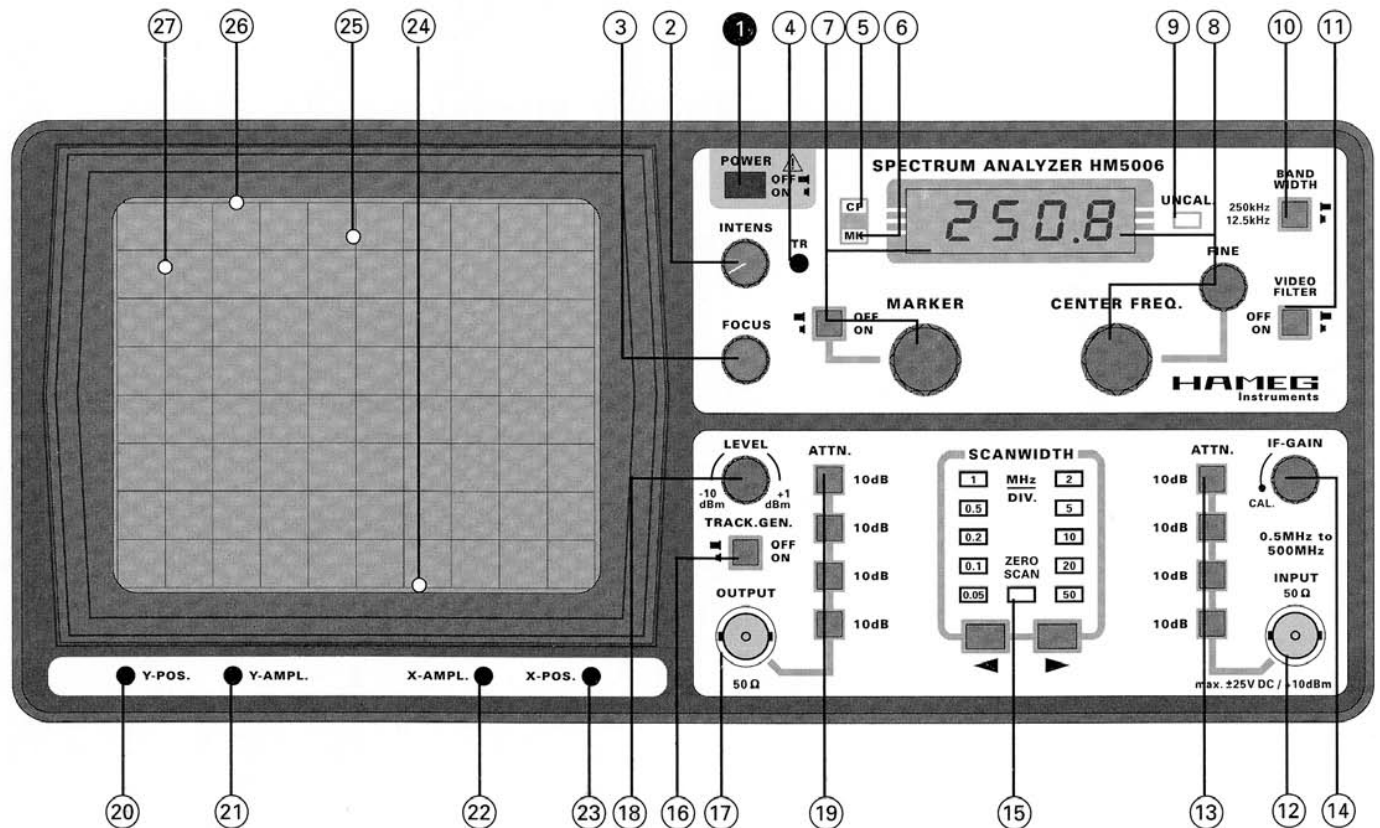

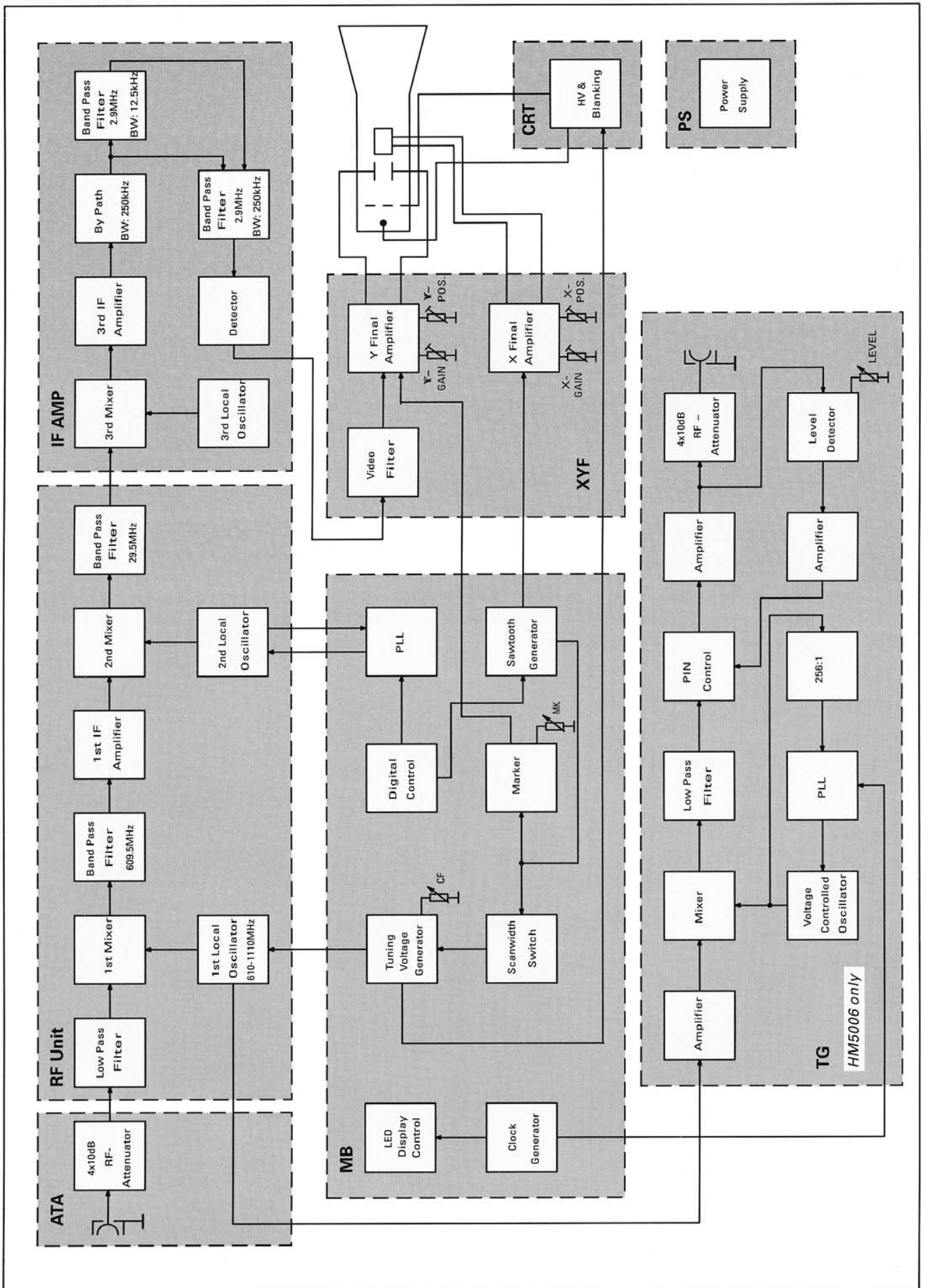

HAMEG

Oscilloscopes

Multimeters

Counter

Generators

**R- and LC-
Meters**

Curve Tracer

Power Supplies

**Spectrum
Analyzer**

Germany

HAMEG GmbH
Kelsterbacher Str. 15-19
60528 FRANKFURT am Main
Tel. (069) 6780510
Telefax (069) 6780513

France

HAMEG S.a.r.l
5-9, av. de la République
94800-VILLEJUIF
Tél. (1) 46778151
Telefax (1) 47263544

Spain

HAMEG S.L.
Villarroel 172-174
08036 BARCELONA
Teléf. (93) 4301597
Telefax (93) 3212201

Great Britain

HAMEG LTD
74-78 Collingdon Street
LUTON Bedfordshire LU1 1RX
Tel. (0582) 413174
Telefax (0582) 456416

United States of America

HAMEG, Inc.
1939 Plaza Real
OCEANSIDE, CA 92056
Phone (619) 630-4080
Toll-free (800) 247-1241
Telefax (619) 630-6507

HAMEG, Inc.
266 East Meadow Avenue
EAST MEADOW, NY 11554
Phone (516) 794-4080
Telefax (516) 794-1855

Hong Kong

HAMEG LTD
Flat 1, 4/F.
Crown Industrial Building
106 How Ming St., Kwun Tong
Kowloon, Hong Kong
Tel. 852-7930218
Fax: 852-7635236