

Precision LCR Meter

LCR-800

USER MANUAL

GW INSTEK PART NO. 82CR-81900M1



ISO-9001 CERTIFIED MANUFACTURER

GW INSTEK

This manual contains proprietary information, which is protected by copyright. All rights are reserved. No part of this manual may be photocopied, reproduced or translated to another language without prior written consent of the Good Will Instrument company.

The information in this manual was correct at the time of printing. However, Good Will continues to improve products and reserves the right to change specifications, equipment, and maintenance procedures at any time without notice.

Good Will Instrument Co., Ltd.
No. 7-1, Jhongsing Rd., Tucheng City, Taipei County 236, Taiwan.

Table of Contents

SAFETY INSTRUCTIONS 5

GETTING STARTED 10

- Main Features 11
- Measurement Type 12
- Front Panel Overview 13
- Rear Panel Overview 16
- Power Up 18
- Fixture Connection 20
- Zeroing 24
- Component Measuring Guidelines 26

BASIC MEASUREMENT 29

- Measurement Item Description 30
- Parameter Configuration 31
- Running Measurement 43
- Store Recall 45

BIN FUNCTIONS 48

- Binning Menu 50
- Set Bin Menu 61
- Bin Summary Menu 68

RS232 REMOTE 72

- LCR Setup 73
- LCR Viewer 74
- Terminal Connection 84

PROGRAMMING 87

- Command Syntax 87
- Commands 90

INTERACE 111

- RS232 Interface Configuration 112
- Signal Overview 116

FAQ 121

APPENDIX 123

- Fuse Replacement 123
- Circuit Theory and Formula 124
- Accuracy Definitions 132
- Specifications 136
- EC Declaration of Conformity 140







INDEX 141

S SAFETY INSTRUCTIONS

This chapter contains important safety instructions that you must follow when operating or storing the LCR-800. Read the following before any operation to insure your safety and to keep the LCR-800 in the best possible condition.

Safety Symbols



These safety symbols may appear in this manual or on the LCR-800.

-  **WARNING** Warning: Identifies conditions or practices that could result in injury or loss of life.
-  **CAUTION** Caution: Identifies conditions or practices that could result in damage to the LCR-800 or to other properties.
-  **DANGER High Voltage**
-  **Attention Refer to the Manual**
-  **Protective Conductor Terminal**
-  **Earth (ground) Terminal**
-  **Do not dispose electronic equipment as unsorted municipal waste. Please use a separate collection facility or contact the supplier from which this instrument was purchased.**

Safety Guidelines

- General Guideline**
 - Do not place any heavy object on the LCR-800.
 - Avoid severe impact or rough handling that leads to damaging the LCR-800.
 - Do not discharge static electricity to the LCR-800.
 - Do not block or obstruct the cooling fan vent opening.
 - Do not perform measurement at circuits directly connected to Mains (Note below).
 - Do not disassemble the LCR-800 unless you are qualified as service personnel.

(Measurement categories) EN 61010-1:2001 specifies the measurement categories and their requirements as follows. LCR-800 falls under category I.

 - Measurement category IV is for measurement performed at the source of low-voltage installation.
 - Measurement category III is for measurement performed in the building installation.
 - Measurement category II is for measurement performed on the circuits directly connected to the low voltage installation.
 - Measurement category I is for measurements performed on circuits not directly connected to Mains.
-  **CAUTION**
- Power Supply**
 - AC Input voltage: 100V-240V, 50-60/400Hz
 - The power supply voltage should not fluctuate more than 110V-240V ±10%.
 - Connect the protective grounding conductor of the AC power cord to an earth ground, to avoid electrical shock.
-  **WARNING**
 - Connect the protective grounding conductor of the AC power cord to an earth ground, to avoid electrical shock.
- Fuse**
 - Fuse type: FUSE 5TT 3A/250V
 - Make sure the correct type of fuse is installed before powering up.
-  **WARNING**

- To ensure fire protection, replace the fuse only with the specified type and rating.
- Disconnect the power cord before fuse replacement.
- Make sure the cause of fuse blowout is fixed before fuse replacement.

- Cleaning LCR-800
- Disconnect the power cord before cleaning.
 - Use a soft cloth dampened in a solution of mild detergent and water. Do not spray any liquid.
 - Do not use chemical or cleaner containing harsh material such as benzene, toluene, xylene, and acetone.

- Operation Environment
- Location: Indoor, no direct sunlight, dust free, almost non-conductive pollution (Note below)
 - Relative Humidity: < 85%
 - Altitude: < 2000m
 - Temperature: 10°C to 50°C

(Pollution Degree) EN 61010-1:2001 specifies the pollution degrees and their requirements as follows. LCR-800 falls under degree 2.

Pollution refers to “addition of foreign matter, solid, liquid, or gaseous (ionized gases), that may produce a reduction of dielectric strength or surface resistivity”.

- Pollution degree 1: No pollution or only dry, non-conductive pollution occurs. The pollution has no influence.
- Pollution degree 2: Normally only non-conductive pollution occurs. Occasionally, however, a temporary conductivity caused by condensation must be expected.
- Pollution degree 3: Conductive pollution occurs, or dry, non-conductive pollution occurs which becomes conductive due to condensation which is expected. In such conditions, equipment is normally protected against exposure to direct sunlight, precipitation, and full wind pressure, but neither temperature nor humidity is controlled.

- Storage environment
- Location: Indoor
 - Relative Humidity: < 85%
 - Temperature: -20°C to 60°C

Disposal



Do not dispose this instrument as unsorted municipal waste. Please use a separate collection facility or contact the supplier from which this instrument was purchased. Please make sure discarded electrical waste is properly recycled to reduce environmental impact.

Power cord for the United Kingdom

When using the LCR-800 in the United Kingdom, make sure the power cord meets the following safety instructions.

NOTE: This lead/appliance must only be wired by competent persons

! WARNING: THIS APPLIANCE MUST BE EARTHED

IMPORTANT: The wires in this lead are coloured in accordance with the following code:

- Green/ Yellow: Earth
- Blue: Neutral
- Brown: Live (Phase)



As the colours of the wires in main leads may not correspond with the colours marking identified in your plug/appliance, proceed as follows:

The wire which is coloured Green & Yellow must be connected to the Earth terminal marked with the letter E or by the earth symbol \oplus or coloured Green or Green & Yellow.

The wire which is coloured Blue must be connected to the terminal which is marked with the letter N or coloured Blue or Black.

The wire which is coloured Brown must be connected to the terminal marked with the letter L or P or coloured Brown or Red.

If in doubt, consult the instructions provided with the equipment or contact the supplier.

This cable/appliance should be protected by a suitably rated and approved HBC mains fuse: refer to the rating information on the equipment and/or user instructions for details. As a guide, cable of 0.75mm² should be protected by a 3A or 5A fuse. Larger conductors would normally require 13A types, depending on the connection method used.

Any moulded mains connector that requires removal /replacement must be destroyed by removal of any fuse & fuse carrier and disposed of immediately, as a plug with bared wires is hazardous if a engaged in live socket. Any re-wiring must be carried out in accordance with the information detailed on this label.

GETTING STARTED

This chapter describes the instrument's main features, front & rear panels, power up sequence, fixture connections and calibration.

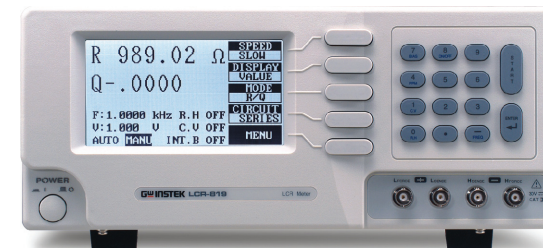

Main Features	Main Features	11
	Model comparison	12
Measurement type	Measurement item	12
	Measurement combination.....	12
Panel overview	Front Panel Overview	13
	Rear Panel Overview.....	16
Setup	Power Up	18
	Tilt stand.....	18
	Power up	18
Fixture connection	Fixture Connection	20
	Fixture structure	20
	Fixture connection.....	21
Bias voltage connection	External voltage bias connection	22
Zeroing	Zeroing.....	24
	Zeroing calibration	24

Main Features

Performance	<ul style="list-style-type: none"> • 12Hz ~ 200kHz wide test frequency (LCR-821) • 5 digit measurement resolution • 2V DC bias voltage • 0.05% basic measurement accuracy (LCR-821/819/817) • 0.1% basic measurement accuracy (LCR-829/827/826)
Operation	<ul style="list-style-type: none"> • Automatic and manual measurements • Dual measurement display • Measurement in absolute values or as a deviation from a nominal value. • Precision four wire fixture • Component Sorting • Up to 30V DC external bias voltage • Internal memory • Large Dot matrix display, 240x128 resolution • Intuitive user interface, comprehensive measurement functions
Interface	<ul style="list-style-type: none"> • RS-232C (LCR-821), LCR-819/817/816 optional • Handler Interface (LCR-829/827/826)

Model comparison

	LCR model						
Test Frequency	821	819	829	817	827	816	826
(12Hz~200kHz)	•						
(12Hz~100kHz)		•	•				
(12Hz~10kHz)				•	•		
(100Hz~2kHz)						•	•

Measurement Types

Measurement item

Primary measurements	Capacitance (C)	Inductance (L)
	Impedance (Z)	Resistance (R)
Secondary measurements	Dissipation factor (D)	Quality factor (Q)(=1/D)
	Resistance (R)	Phase Angle (θ)

Measurement combination



●:Available, —:Not available



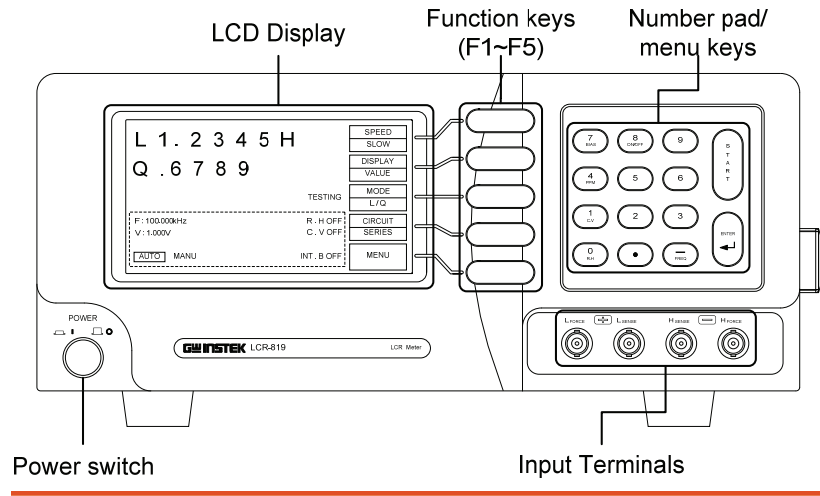

1st measurement	2nd measurement				Circuit model	
	Q	D	R	θ	Series	Parallel
Capacitance (C)	—	●	●	—	●	●
Inductance (L)	●	—	●	—	●	●
Impedance (Z)	—	—	—	●	●	—
Resistance (R)	●	—	—	—	●	●

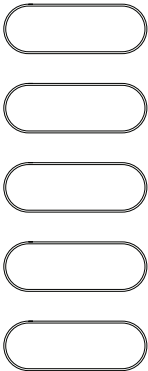
*Only the LCR-821 can select L/R and Z/θ measurement modes.

Front Panel Overview

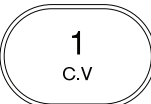
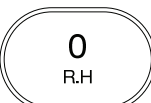

- Power switch
- LCD Display 240 by 128, dot matrix LCD display.
- Function keys  Assigned to the menu on the right side of the display.
- Number pad/menu keys  Used to enter numerical values or access secondary menu functions.

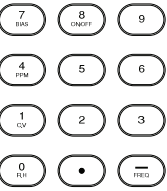
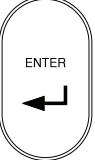
- 7. Bias  The bias key selects an internal or external bias. The bias will be displayed on the bottom of the LCD display as INT.B (internal bias) or EXT.B (external bias).
- 8. On/Off  The On/Off key turns the internal or external bias on or off.
- 4. PPM  Measures Dissipation and Quality factor as PPM.
- 1. C.V  Turns constant voltage mode on or off.
- 0. R.H  Used to turn Range Hold On or Off.
- . FREQ  Used to enter test frequencies.
- Numerical numbers  Used to enter numbers, decimals and negative values.
- Enter  The Enter key is used to confirm menu and number entries.

Start

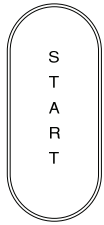

The Start key is used to start measuring when in manual mode.

The start key can also be used to select automatic or manual measuring modes.

Hold the Start key for 3 seconds to toggle between auto and manual mode.

Terminals

Force and Sense terminals

- | | |
|--------|----------------|
| LFORCE | Current return |
| LSENSE | Low potential |
| HSENSE | High potential |
| HFORCE | Current output |

Force and Sense terminals

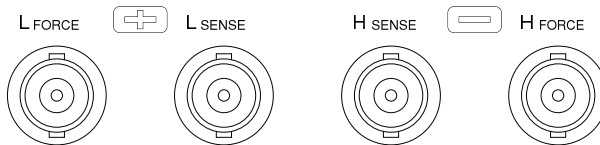

Power Switch

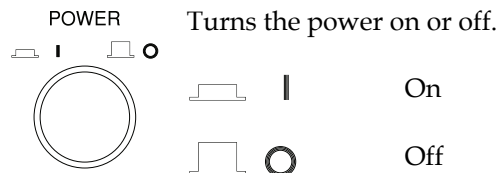

Rear Panel Overview

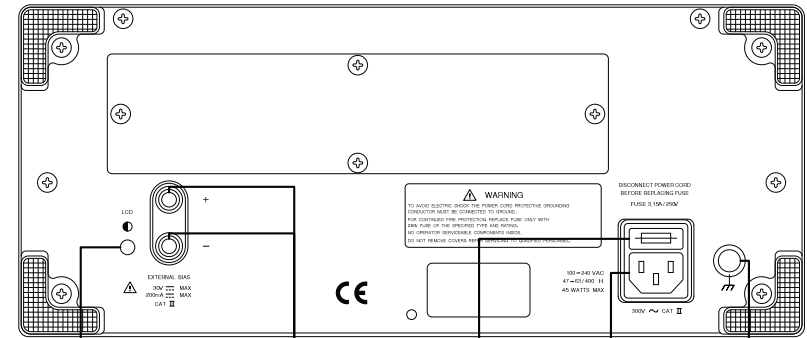

Contrast control External bias Fuse Power socket Ground

LCR-819, LCR-817, LCR-816

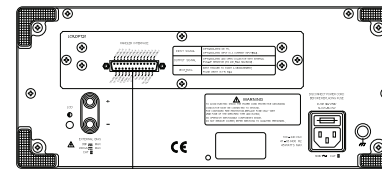

Handler Interface

LCR-829, LCR-827, LCR-826

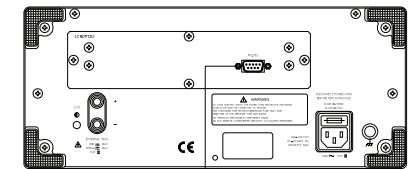

RS232

LCR-821

Contrast control

LCD



The LCD contrast control

External Bias

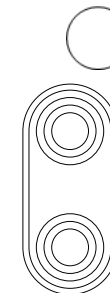

The positive and negative external bias.

30V (35V tolerable) Max voltage

200mA Max current

Fuse / Power Socket

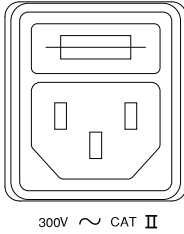

The fuse holder contains the main fuse, 5TT 3A/250V. For fuse replacement details, see page 123.

The mains socket accepts the power cord. See page 18 for power-up details.

Ground

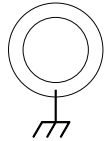

Ground input.

Handler Interface

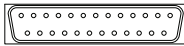

Handler interface for binning (LCR-829/827/826 only).

RS-232 Interface

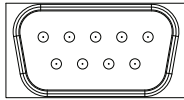

RS232 interface (LCR-821). RS232 interface is used for remote control with the LCR-Viewer software. RS232 is also available as a factory installed option (LCR-816/817/819).

Power Up

Tilt stand

Low Angle

Ensure the stand is up.

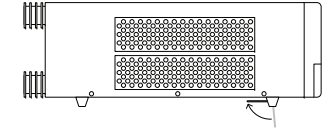

High Angle

Ensure the stand is down.

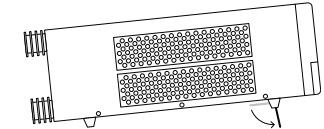

Power up

Panel operation

1. Connect the power cord to the socket.

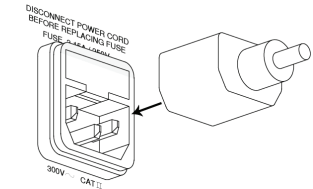

2. Press the power button. The display becomes active in 2~3 seconds.

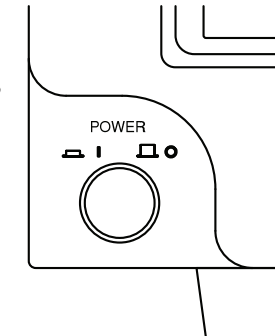

3. Use the contrast knob on the rear panel to adjust the LCD display contrast.

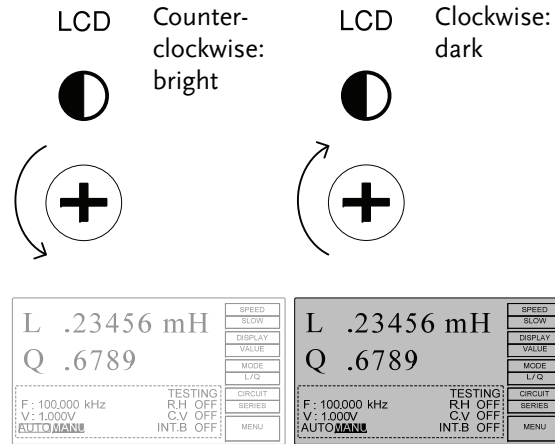

Fixture Connection

Fixture structure

Background The standard fixture is a four-wire type (Kelvin 4 wire). The outer terminals (Hforce and Lforce) provide the current and the inner terminals (Hsense and Lsense) measures the potential.

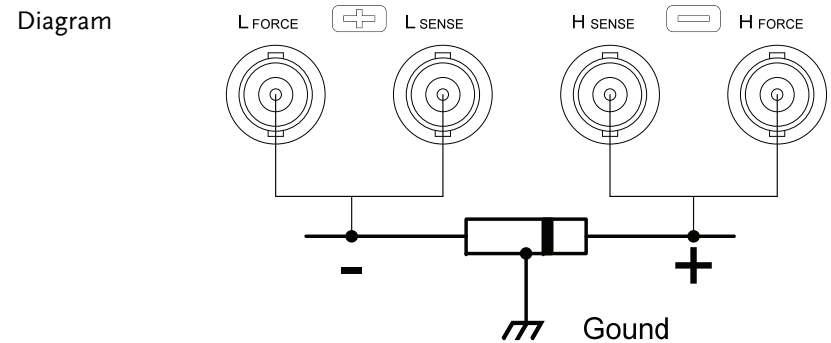

Description	Terminal	Function
	HFORCE	Carries the signal current source. Connected to the + side of the device under test.
	HSENSE	Together with Lsense, monitors the Potential. Connected to the + side of the device under test.
	LSENSE	Together with Hsense, monitors the Potential. Connected to the - side of the device under test.
	LFORCE	Accepts the signal current return. Connected to the - side of the device under test.
	GND	If the test component has a large metal area NOT connected to either of the terminals, connect to the GND input to minimize noise level.

Fixture connection

- Panel operation
1. Discharge the test component before connecting the fixture set.
 2. Connect the Kelvin clip test lead into the front terminals. Line the lead fixture up to the front terminals and slide in. Turn the BNC handle counter clockwise to unlock the fixture. Turn the handles clockwise to lock the fixture.

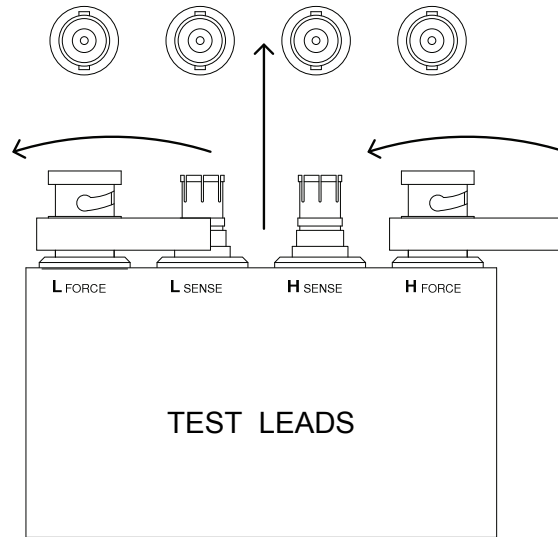

3. Connect the fixture to the test component. If the component has polarity, connect the H side to the positive lead and the L side to the negative lead. Make sure the distance between the lead base and fixture clip is short enough.

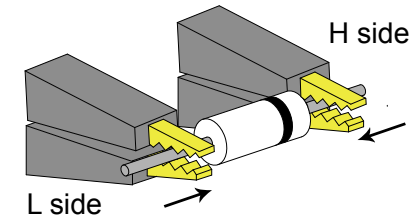

4. If the test component has an outer case unconnected to either of the leads, connect to the ground terminal for noise level reduction.

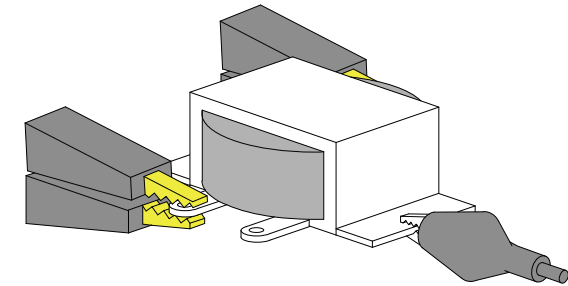

External voltage bias connection

Background

An external voltage bias of 0-30 volts with a maximum of 200mA can be applied to the external voltage bias terminals on the rear panel. The external bias voltage must be floating and not connected to ground. For details for setting the external bias voltage see page 34.

1. Connect the voltage bias terminals to a bias voltage. Leave ground floating.

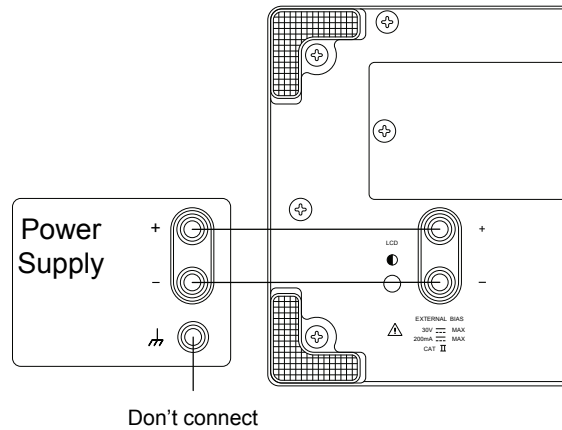

Zeroing

Zeroing calibration

Background

Open and short circuit calibration (zeroing) should be performed on a daily basis to correct for cable and fixture errors before taking measurements. When test fixtures or test cables are changed, the zeroing process should be performed again. All data performed during the calibration is stored in the internal memory of the LCR-800.

The Open circuit calibration determines the stray admittance and compensates high impedance measurements. The short calibration determines the residual impedance and is used when determining low impedance measurements.

Open circuit

The Open circuit calibration measures the stray admittance of the test fixture. This is used for high impedance measurements.

Procedure

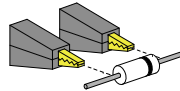
1. Insert the test fixture or cable. Ensure the cables are not shorted and are open. 
2. Press the MENU key, then OFFSET, followed by CAP OFFSET.

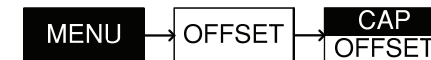

3. Wait for the calibration to finish. If the OPEN TEST was successful, the screen will display the following message:

OPEN TEST

OK

 **Warning** If the test failed, ensure your cables or test fixtures are open and not shorted. Ensure R.H is OFF. After inspection try again.

Short circuit The short test will calibrate the short circuit impedance of the cables or test fixtures. This is used for low impedance measurements

4. Short the cables or test fixtures using a short thick copper wire if necessary.

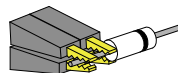

5. Press R/L offset in the offset menu.



6. Wait for the calibration to finish. If the SHORT TEST was successful the following message is displayed.

SHORT TEST **OK**

 **Warning** If the test failed, ensure your cables or test fixtures are shorted. Ensure R.H is OFF. After inspection try again.

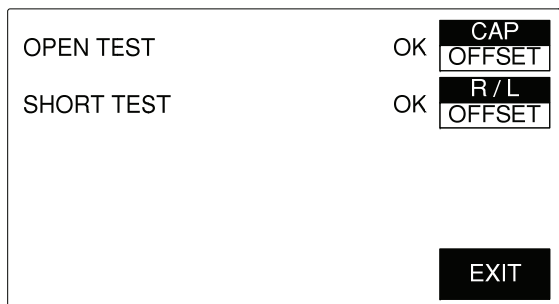

7. Press EXIT when both tests are OK.



 **Warning** Failure to pass both tests will result in erroneous measurements.

Component Measuring Guidelines

Background For measuring Impedance, Capacitance, Inductance, and Resistance, series or parallel equivalent circuit models are available. Usually a component manufacturer will specify how a component should be measured and at what frequency. If not, use the guidelines below. Select the equivalent circuit and frequency according to the component value. For more information about equivalent circuit models and theory see page 124.

General Inductors Inductors have always traditionally been measured in series equivalent circuits. For large inductors a lower test frequency yields more accurate results. For small inductors, higher frequencies are more accurate.

Test Frequency	Expected Inductance			
	<10uH	10uH~1mH	1mH~1H	>1H
0.1kHz	—	—	—	Series
1kHz	—	—	Series	—
10kHz	—	Series	—	—
100kHz	Series	—	—	—

General Capacitors Capacitors are usually measured in series except for extremely small capacitance. Like with inductors, larger capacitors should be measured with low frequencies. Small capacitors with high frequencies.

Test Frequency	Expected Capacitance			
	<10pF	10pF~400pF	400pF~1uF	>1uF
0.1~0.12 kHz	—	—	—	Series
1kHz	—	—	Series	—
10kHz	—	Series or Parallel	—	—
100kHz	Parallel	—	—	—

General Resistors A series inductance circuit is the best equivalent circuit for low resistance (<1kΩ) and a parallel capacitance circuit for high resistances (>10MΩ).

Test Frequency	Expected Resistance		
	<1kΩ	1kΩ~10MΩ	>10MΩ
0.03kHz	—	—	Parallel
0.25kHz	—	Parallel	—
1kHz	Series	—	—

Metal component case connection A large area of metal can add noise to the measurement. Here is how to minimize the effect.

If the metal is connected to one of the terminals, this should be connected to the Hforce terminal side.

If the metal is NOT connected to either of the terminals, connect to the GND terminal.

Wire capacitance When measuring the wire capacitance, the fixture clips that are marked with H_F(High Force)/H_S (High Sense) should always be connected to the point that is influenced the most by noise.

Air-cored coils Air-cored coils can pick up noise very easily, therefore they should be kept well clear of any test equipment that may contain power transformers or display scan circuitry. Also, keep the coils away from metal objects which may modify inductor characteristics.

Iron-cored and ferrite inductor The effective value of iron-cored and ferrite inductors can vary widely with magnetization and test signal level. Measure them at the AC level and frequency in use. Unlike most inductors, a parallel equivalent circuit is most suitable for iron-cored inductors. When core materials are damaged by excessive magnetization (for example: tape heads and microphone transformers), check that the test signal is acceptable before connection.

BASIC MEASUREMENT

Basic Measurement details how to measure individual components and how to configure the LCR-800 settings. Basic Measurement also describes how to save and recall memory. Advanced functions such as the handler menu or remote control are detailed on page 48 and 72, respectively.

Measurement Description	Measurement Item Description.....	30
	Measurement combination.....	30
	Display overview.....	30
Configuration	Parameter Configuration.....	31
	Measurement Speed.....	31
	Select equivalent circuit type.....	33
	Set Bias voltage.....	34
	Set measurement frequency.....	35
	Set measurement voltage.....	37
	Set PPM for D/Q measurements.....	38
	Set constant voltage source.....	39
	Set Range hold.....	40
	Set Average.....	40
Set Nominal Values.....	41	
Measurement	Running Measurement.....	43
	Select Single measurement.....	43
	Select Automatic measurement.....	44
Store/Recall	Store Recall.....	45
	Store or Recall Memory Settings.....	45
	Recall Calibration Settings.....	46

Measurement Item Description

In general, two measurement items, primary and secondary, are combined in a single measurement. The following table shows the available combinations. Details of the measurement modes and the circuit theory and formula can be found in the appendix, page 124.

Measurement combination

●:Available, —:Not available

1st measurement	2nd measurement				Circuit model	
	Q	D	R	θ	Series	Parallel
Capacitance (C)	—	●	●	—	●	●
Inductance (L)	●	—	●*	—	●	●
Impedance (Z)	—	—	—	●*	●	—
Resistance (R)	●	—	—	—	●	●

*LCR-821

Display overview

Normal mode

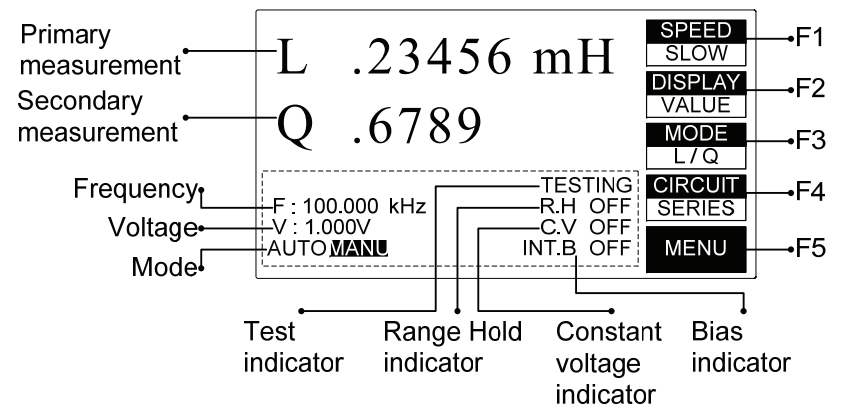

Parameter Configuration

Measurement Speed

Measurement Speed The LCR-800 series support 3 different measurement speeds: slow, medium or fast at approximately 1, 5 or 12 (LCR-829/827/826) measurements per second. The faster the measurement speed, the lower the accuracy. Conversely the slower the measurement speed, the higher the accuracy. The measurement speed and accuracy are dependent on the mode, voltage and frequency. For detailed information, see the specification table on page 136.

LCR-817/819/821	Accuracy	Measurements/second
	Slow 0.05%	At least 1
	Medium 0.1%	At least 3
Fast 0.24%	At least 7	
LCR-816/826/827/829	Accuracy	Measurements/second
	Slow 0.1%	At least 1
	Medium 0.2%	At least 3
	Fast 0.48%	At least 7

Panel operation 1. From the main menu, press the **SPEED SLOW** menu key to cycle between the various speeds.



Displayed measurement unit

Measurement units All measurement unit results can be displayed as the absolute values, delta values or delta percentage values.

Value will show the absolute value of the measurement in Ohms (Ω), Henries (H) or Farads (F). The primary measurement has resolution of 5 digits; the secondary has a resolution of 4 digits (θ , 2 digits).

Delta% will show the percentage deviation of L, C, R or Z from a nominal (stored) value.

Delta will show the deviation from a nominal value as an absolute value in Ohms (Ω), Henries (H) or Farads (F).

	Units
Value	Ω , H, F
Delta	Absolute deviation (Ω , H, F)
Delta%	% deviation

Panel operation 1. From the main menu, press the **DISPLAY VALUE** menu key to cycle between the display types.



Measurement Modes

Measurement mode The LCR-800 has a number of different measurement modes. Primary and secondary measurements are displayed on the screen simultaneously. For detailed information regarding the measurement combinations, see the specifications on page 136. The measurement combinations are shown in the table below.

(C/D)	Capacitance/Dissipation
(C/R)	Capacitance/Resistance
(L/R)*	Inductance/Resistance
(L/Q)	Inductance/Quality factor
(Z/θ)*	Impedance/Angle
(R/Q)	Resistance/Quality factor

Panel operation 1. From the main menu, press the MODE menu key to cycle between the different modes.



*Only the LCR-821 can select L/R and Z/θ measurement modes.

Select Equivalent Circuit Type

Background Series or Parallel equivalent circuits can be selected. Not all measurement modes can be used with both series and parallel equivalent circuits. For details about circuit types see the circuit theory chapter on page 124.

Measurement type	Series	Parallel
Capacitance (C)	●	●
Inductance (L)	●	●
Impedance (Z)	●	—
Resistance (R)	●	●

Panel operation 1. From the main menu, press the CIRCUIT menu key to cycle between the series or parallel equivalent circuits.

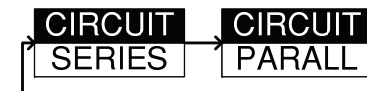

Series

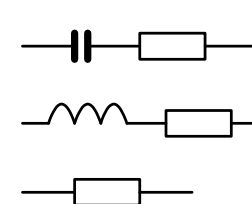

Parallel

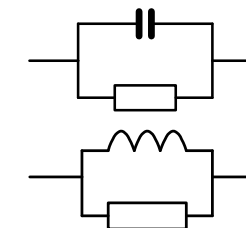

Set Bias voltage

Background

Voltage bias can be set internally or externally. An internal voltage bias of 2 volts is normally applied to a DUT. External voltage bias is able to accept 0 to 30 volts with a maximum current of 200mA. For external bias voltage connections see page 22. When measuring a DUT, please allow 1 second to stabilize a DUT after a bias voltage is applied. In general a bias voltage should only be applied to capacitors. If a bias voltage is applied to devices with low impedance, inaccurate measurements will occur.



When an external voltage is applied, constant voltage mode (C.V.ON) must be enabled, page 39.

Panel operation

1. Press the 7/Bias key on the number pad to cycle from internal to external bias. The bottom of the screen will display internal or external bias.

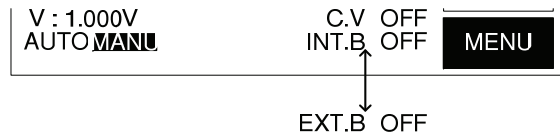

2. Press 8/ON/OFF to turn the bias voltage on or off. The bottom of the screen will display the internal or external bias as on or off.

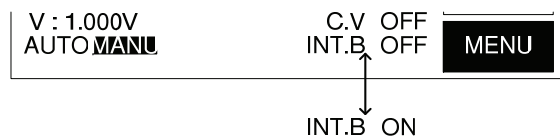

Set measurement frequency

Background

The measurement frequency, together with the measurement voltage is used to define the electrical characteristics of each measurement item. Make sure the appropriate frequency is selected according to the component characteristics.

The frequency range of each model is as follows:

100Hz~2kHz	LCR-816/826
12Hz~10kHz	LCR-817/827
12Hz~100kHz	LCR-819/829
12Hz~200kHz	LCR-821

The LCR-821 can provide 504 different frequencies with a 5 digit resolution including decimal places. Any frequency can be keyed from the number pad, and the closest available frequency (of 504) will be selected automatically. The LCR-818/829 has 503 different frequencies and the LCR-817/827 and LCR-816/826 have 489 and 245, respectively.

To calculate the different possible frequencies, use the tables below.

	Frequency range	Formula	n range
LCR-821	0.012 To 0.23077kHz	3kHz/n	13 to 250
	0.23438 To 15kHz	60kHz/n	4 to 256
	15.385 To 200kHz	200kHz/n	1 to 13
LCR-819/829	0.012 To 0.23077kHz	3kHz/n	13 to 250
	0.23438 To 15kHz	60kHz/n	4 to 256
	15.385 To 100kHz	200kHz/n	2 to 13
LCR-817/827	0.012 To 0.23077kHz	3kHz/n	13 to 250
	0.23438 To 10kHz	60kHz/n	6 to 256
LCR-816/826	0.10000 To 0.23077kHz	3kHz/n	13 to 30
	0.23438 To 2kHz	60kHz/n	30 to 256

Panel operation

1. Press the -/FREQ key on the number pad.



2. Enter the frequency using the numerical keys, and then press ENTER.

1.0kHz

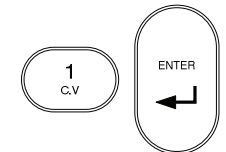

1.1kHz

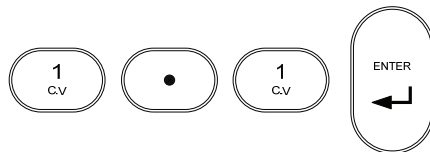

The nearest frequency will be selected from the 504(LCR-281) nominal frequencies, and updated in the display. Here, the nearest frequency to 1.1kHz is 1.0909kHz.

F : 1.0909 kHz



Note

After the test frequency has been changed, the zeroing must be performed again. See page 24

Set measurement voltage

Background	Along with frequency, voltage can be set. Make sure the appropriate voltage is selected, according to the component characteristics.
Range	5mV ~ 1.275V (5mV steps) <200kHz 100mV ~ 1.275 (5mV steps) @200kHz

- Voltage setting
- From the main menu, press MENU (F5) followed by SETTING (F3) and VOLT (F2)



- Enter the voltage using the numerical keys, and then press ENTER.

100mV

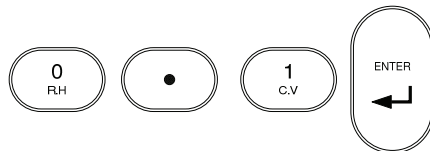

1V

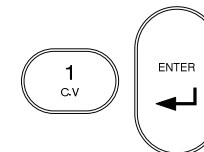

MEMORY NO: 1	MEMORY
	1
VOLTAGE= 1.000 v	VOLT
	1.000
AVERAGE= 1	AVGE
	1
RECALL CALIBRATION	RECALL
	EXIT

The voltage is updated in the display. If the voltage entered is outside the allowable voltage range, the nearest voltage is selected.

- Press (F5) EXIT to exit the Setting menu.



Set PPM for D/Q measurements

Background Dissipation and Quality Factor (D/Q) measurements can be shown in parts per million (PPM) if D/Q is less than 0.0100. This increases the resolution by a factor of 100. The units of D and Q are dimensionless and are expressed as a decimal ratio with a multiplier of 1,000,000.

Ensure the operating mode has a D or Q component. See page 33.

- Panel operation
- Press 4/PPM to turn PPM on or off for all D/Q measurements

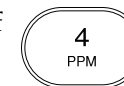

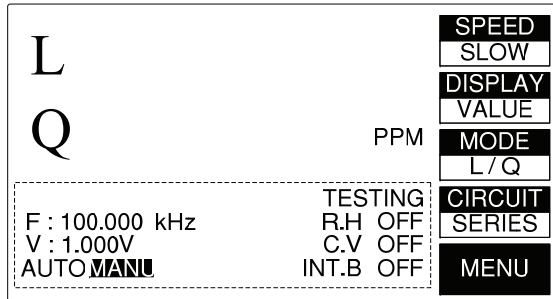

PPM will be displayed on the right hand side of the screen, next to mode.

Set constant voltage source

Background If a DUT needs to be tested at a set voltage, the constant voltage function can be used. Using the C.V. function the LCR will maintain a source resistance of 25Ω. Therefore the test voltage is constant for any DUT impedance greater than 25Ω. Using the constant voltage feature will reduce the accuracy of measurements by a factor of 3.

- Panel operation** 1. Press 1/C.V to turn constant voltage on or off.

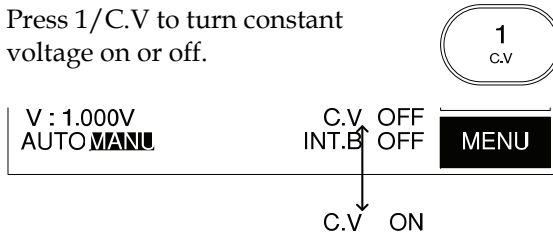

C.V ON / OFF is toggled each time the 1/C.V button is pressed.

Set Range hold

Background When DUTs are disconnected from the test cables/ fixtures during continuous testing, Range Hold can be used to avoid range switching. This is particularly useful for repetitively testing a number of DUTs. For more information on Range and range hold, see the specifications, page 136.

- Panel operation** 1. Press 0/R.H to turn Range Hold on or off.

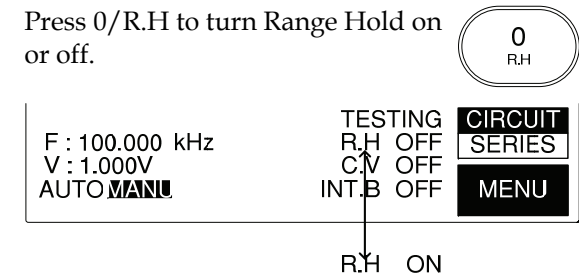

R.H ON / OFF is toggled each time the 0/R.H button is pressed.

Set Average

Background An arbitrary number of tests can be averaged to produce an averaged test result. 1-255 tests can be averaged. The larger the number of tests that are averaged, the longer the test time.

- Panel operation** 1. From the main menu, press MENU, followed by SETTING and AVGE.



2. Enter the number of number of averages (tests) using the numerical keys, and then press ENTER.

The average of 10 tests

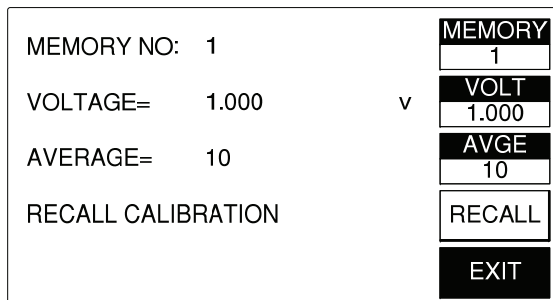
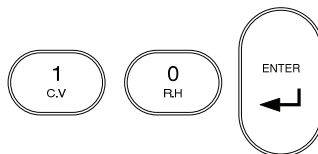

The number of averages is displayed in the main panel and in the AVGE menu icon after a short processing time.

2. Press EXIT to exit to the main menu. **EXIT**

Set Nominal Values

Background The LCR-800 series are able to set nominal values when using the DELTA and DELTA% measuring modes. Nominal values can be set to up to 5 digits including decimal places. Each primary measuring unit can have the nominal value set.

- Panel operation**
1. From the main menu, choose the measuring mode that you wish to change by pressing (F3) MODE until the correct measuring mode is displayed. **MODE**
L/Q

For example, if L/Q mode is selected, an inductance (mH) nominal value can be set.

Inductance (L)	H, mH
Capacitance (C)	nF, uF, pF
Impedance (Z)	Ω , K Ω
Resistance (R)	Ω , K Ω

3. Press MENU (F5), followed by SORT (F2) and NOM.VAL (F1).

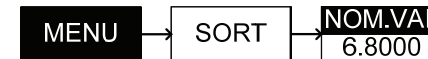

3. Enter the nominal number using the numerical pad, followed by ENTER. Up to 5 digits can be entered.

0.6800mH

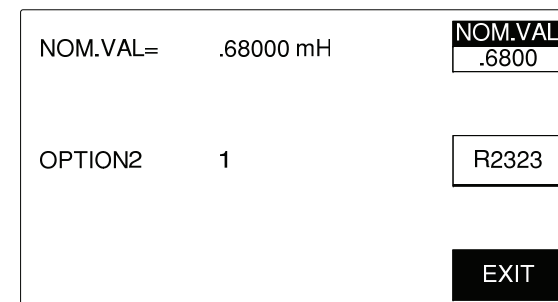
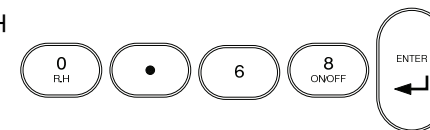

The NOM.VAL key and screen will be updated when a nominal value is entered.

4. Press EXIT to exit to the main menu. **EXIT**

Running Measurement

Select Single measurement

Background Measurements can be manually controlled (MANU) or automatically updated (AUTO).
In manual mode, one measurement is performed by pressing the start key.

Panel operation 1. Press the START key to manually perform a measurement when in manual mode.

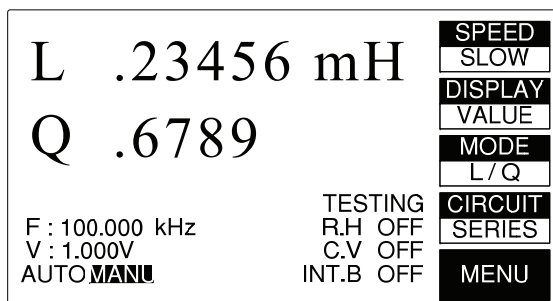
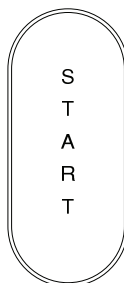

TESTING will appear on the screen, followed by the measurement results. The duration of the test will depend on the measurement accuracy and the number of averages used.

Select Automatic measurement

Background Measurement can be manually controlled (MANU) or automatically updated (AUTO).
In continuous mode (AUTO), measurements are automatically done and the display is updated according to the measurement speed setting.

Panel operation

1. Hold the START key for a few seconds to toggle between automatic (AUTO) and manual (MANU) mode.
2. When in AUTO mode, measurements will start automatically until AUTO mode is switched back to MANU.

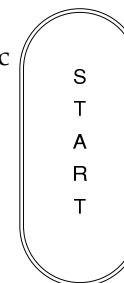

The bottom of the screen will indicate if AUTO or MANU mode is activated.

Testing will appear on the screen each time a measurement is completed.

Store Recall

Store or Recall Memory Settings

Background The LCR-800 series have 100 blocks of memory available for saving settings.

Note All memory is stored using an internal battery. The battery should last 3 years before replacement. If any files cannot be saved or recalled, please contact your local GW Instek distributor to have the battery changed.

The LCR-827/829 can also use the stored memory settings for Binning (page 48)

Panel operation 1. From the main menu, press MENU, SETTING AND MEMORY.



2. Press 2 to save the current measurement settings, or 1 to recall a previously saved memory setting. OR

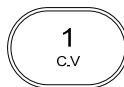
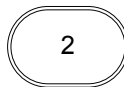

3. Use the number pad to select a memory number and ENTER to confirm the selection. Range: 1~100

Memory slot 10

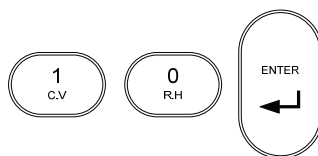

4. The RECALL NO. or STORE NO. will be set accordingly.

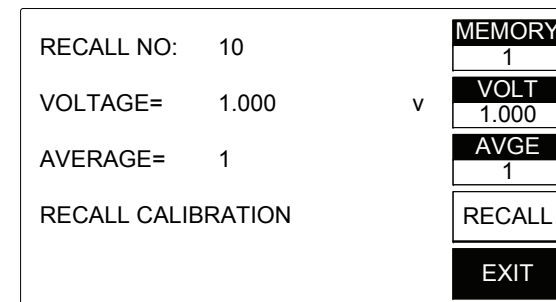

5. Press EXIT to exit to the main menu.



Cancel 6. Press ENTER at any of the memory options to cancel.

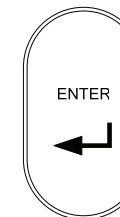

Recall Calibration Settings

Background When measurement values are inaccurate, original calibration settings can be recalled.

Panel operation 1. From the main menu, press MENU, SETTING AND RECALL.



2. Press 1 to recall the calibration settings or 2 to cancel.

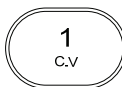

OR

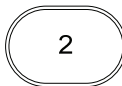

3. When the status bar has completed, the calibration settings are recalled.

4. Press EXIT to exit to the main menu.



CAUTION

If the function keys are not active after calibration settings have been recalled, DO NOT turn off the instrument. Wait a few minutes and try again.

BIN FUNCTIONS

The Handler interface is used to sort components into different bins. The handler menu compares results from a number of different user defined limits. Component sorting can be accomplished in either manual or automatic mode. For more information on using the handler interface to sort components please see page 114.

Bin Functions	<ul style="list-style-type: none"> Handler Menu Overview50 Handler Menu52 Mode Setting52 Circuit Setting53 Speed Setting53 Display Setting54 Frequency Setting54 Select/Run Auto/Manu Sorting55 Voltage Setting56 Bias Setting57 Constant Voltage Setting58 Delay Setting59 Average Setting60
Set Bin Menu	<ul style="list-style-type: none"> Set Bin Menu Overview61 Bin Menu62 Sort Type63 Bin Number64 Set Nominal Value64 Set Max/Min Absolute Limit65 Set Max/Min Percentage Limit65 Set Max/Min Secondary Measurement Limits66 Clear Bins67 Exit Set Bin Menu67

Bin Summary	Bin Summary Menu Overview	68
Menu	Bin Summary/Results.....	70

Binning Menu

Handler Menu Overview

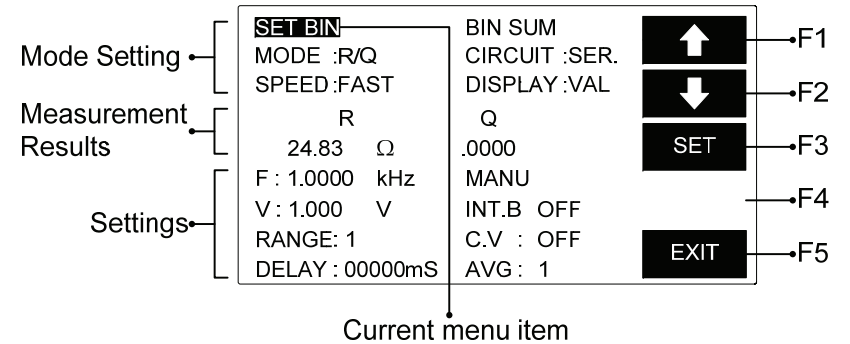

Mode Setting The mode setting area shows basic settings for the current bin mode.

SET BIN Configures the Bin settings

MODE Measurement mode

SPEED Measurement speed

BIN SUM Displays the Bin test results

CIRCUIT Selects between serial and parallel circuits

DISPLAY Selects what measurement unit is displayed.

Parameter BIN, VALUE, OFF

Measurement Results The primary and secondary measurement results are displayed.





Settings The testing settings for the DUT can be edited here.

F Frequency - model dependant

V Voltage – model dependant

Range Displays the current range

	Parameter 1,2,3,4
Delay	Delay between each measurement
	Parameter 0~99999 ms
MANU/ AUTO	Selects between automatic and manual mode
	Parameter Auto, Manu
INT.B/EXT.B	Internal and External voltage Bias
	Parameter INT.B, EXT.B
C.V	Constant voltage
	Parameter On, Off
AVG	Number of Averages
	Parameter 1-255

Menu Keys		Scroll up through the menu items
		Scroll down through the menu items
		Edit the menu items
		Exit the menu





Handler Menu

Background Before Bin Sorting, the measurement settings must be configured.

Panel operation 1. To access the handler menu, press MENU, SORT, HANDLER from the main menu.



2. The Handler menu appears.

SET BIN	BIN SUM	
MODE :R/Q	CIRCUIT :SER.	
SPEED :FAST	DISPLAY :VAL	
R	Q	
24.83 Ω	.0000	
F : 1.0000 kHz	MANU	
V : 1.000 V	INT.B OFF	
RANGE: 1	C.V : OFF	
DELAY : 00000mS	AVG : 1	

Mode Setting

Background Use the mode setting to change the measurement mode in the handler menu.

Panel Operation 1. Use the arrow menu keys (F1/F2) to move the cursor to MODE.



MODE :R/Q

2. Press SET repeatedly to scroll through the different modes.

R/Q → C/D → C/R → L/Q



Circuit Setting

Background Use Circuit setting to change the equivalent circuit.

- Panel Operation 1. Use the arrow menu keys (F1/F2) to move the cursor to CIRCUIT.
- 

- CIRCUIT** :SER.
2. Press SET repeatedly to select either serial or parallel circuits.
- 
- | | |
|------|------------------|
| SER. | Serial Circuit |
| PAR. | Parallel Circuit |



Speed Setting

Background Use the Speed setting to change the measurement speed.

- Panel Operation 1. Use the arrow menu keys (F1/F2) to move the cursor to SPEED.
- 

- SPEED** :FAST
2. Press SET repeatedly to select FAST, MEDIUM or SLOW.
- 



Display Setting

Background Use the Display setting to change the measurement results as values or bins.

- Panel Operation 1. Use the arrow menu keys (F1/F2) to move the cursor to Display.
- 

- DISPLAY** :VAL.
2. Press SET repeatedly to make a selection.
- 
- | | |
|------|--|
| VAL. | Display the primary and secondary measurement results as values. |
| BIN | Display the bin result (BIN1~13) |
| OFF | Don't display results |

Frequency Setting

Background Set the testing frequency.

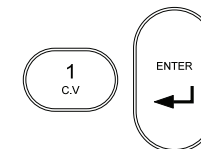
- Panel Operation 1. Use the arrow menu keys (F1/F2) to move the cursor to F (Frequency)
- 

- F** : 1.0000 kHz
2. Use the number pad to enter a frequency and press ENTER to confirm.
- 1.0000kHz



Select/Run Auto/Manu Sorting

Background Set the test mode from manual to automatic.

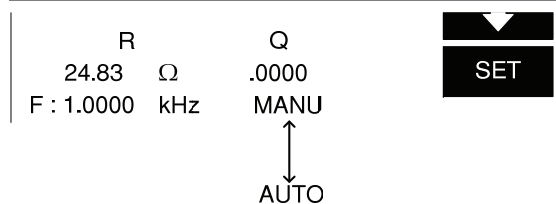
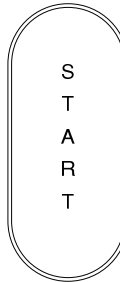
- Panel operation 1. Hold the START key for a few seconds to toggle from automatic or manual bin sorting.



The center of the screen will indicate if AUTO or MANU mode is activated.

2. To test in MANU mode, press the START key for each test. Testing will begin automatically in AUTO mode.

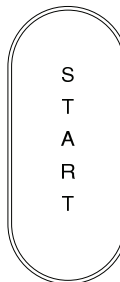

3. Results will be updated in the display, depending on the settings. Each time a test result has been completed, an asterisk will appear on the screen.

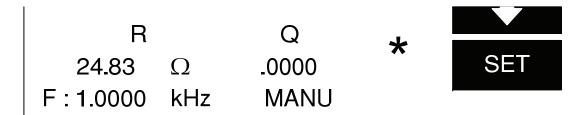

Voltage Setting

Background Set the testing voltage.

- Panel Operation 1. Use the arrow menu keys (F1/F2) to move the cursor to V (Voltage)

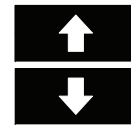

2. Use the number pad to enter a voltage and press ENTER to confirm.

1.000 V

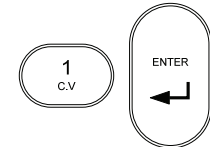

Bias Setting

Background Set internal or external bias voltage.

- Panel Operation 1. Use the arrow menu keys (F1/F2) to move the cursor to INT.B or EXT.B.



INT.B OFF

2. Press INT (F3) to use internal biasing.



3. Press EXT (F4) to use external biasing.



4. Use the arrow menu keys to highlight OFF/ON.



INT.B **OFF**

5. Press ON (F3) to turn bias voltage on.



6. Press OFF (F4) to turn bias voltage off.



Range Setting

Background The range can be selected from 1 to 4. Different ranges should be used for different components and component values and to ensure accurate readings.

	Component		
	Inductor	Capacitor	Resistor
Range1	1~16mH/f	1.6~25uF/f	6.25~100Ω
Range2	16~256mH/f	100~1600nF/f	0.1~1.6kΩ
Range3	256~4100mH/f	6.4~100nF/f	1.6~25.6kΩ
Range4*	4.1~65H/f	400~6400pF/f	25.6~410kΩ

f = test frequency in kHz

* This range is not used above 20 kHz

- Panel Operation 1. Use the arrow menu keys (F1/F2) to move the cursor to RANGE.



RANGE: 1

2. Press F3 (UP) to increase the range or F4 (DOWN) to decrease the range.





Constant Voltage Setting

Background Constant voltage is usually used when a set voltage is needed. For details about constant voltage, see page 39.

- Panel Operation 1. Use the arrow menu keys (F1/F2) to move the cursor to C.V.





C.V : OFF

- 2. Press ON (F3) to turn constant voltage on. 
- 3. Press OFF (F4) to turn constant voltage off. 

Delay Setting

Background The Delay Setting determines the delay time in milliseconds between each measurement.

 **Note** Delay time can also delay the menu response. When the instrument is in AUTO mode, any panel key presses will be delayed as well. This will result in a delay proportional to the Delay Settings.

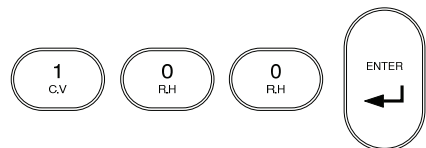

- Panel Operation** 1. Use the arrow menu keys (F1/F2) to move the cursor to DELAY. 

- DELAY : 00000mS**

- 2. Use the number pad to enter the delay time followed by the Enter key
100ms



Average Setting

Background The average function chooses how many averages (1-255) are used for each measurement.

- Panel Operation** 1. Use the arrow menu keys (F1/F2) to move the cursor to AVERAGE. 

- AVG : 1**

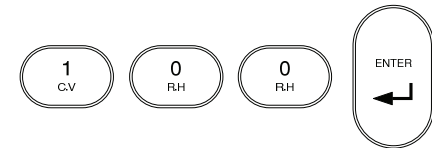
- 2. Use the number pad to enter the number of averages followed by the Enter key
100 averages





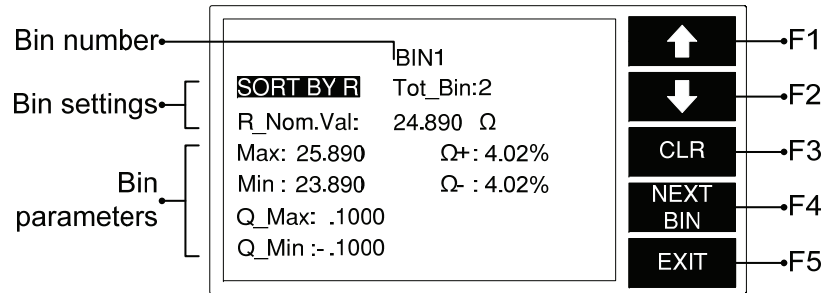

Set Bin Menu

Set Bin Menu Overview



Bin number	Displays the current bin.
Bin Settings	Configures the nominal value, nominal units and the total amount of bins.
SORT BY	Chooses the primary or secondary measurement to sort test results.
Tot_Bin	Configures the amount of sort bins.
R_Nom.Val	Sets the nominal value, depending on the SORT BY R/Q settings.
Q_Nom.Val	
Bin parameters	Configures the maximum and minimum sort limits for the current bin.
Max: Ω+	Sets the maximum bin as an absolute value.
Max: Ω-	Sets the minimum bin as an absolute value
Ω+:	% Sets the maximum bin value as a positive percentage offset from the nominal value.
Ω-	% Sets the minimum bin value as a negative percentage offset from the nominal value.

Q_Max	Sets the Maximum Q value for the current bin.
Q_Min	Sets the minimum Q value for the current bin.

Menu Keys		Scroll up through the menu items
		Scroll down through the menu items
		Clears the current bin settings.
		Goes to the next bin.
		Exit the menu

Bin Menu

Background Before Bin Sorting, the measurement settings must be configured

- Panel operation
- To access the handler menu, press MENU, SORT, HANDLER.



- The Handler menu appears.

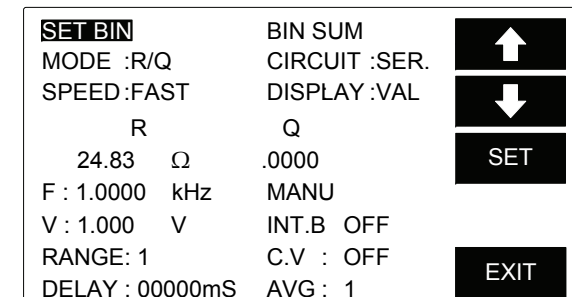

- Use the arrow menu keys (F1/F2) to move the cursor to SET BIN.

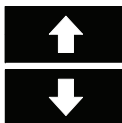

SET BIN

- Press SET (F3).



- The Bin menu appears.

BIN1		
SORT BY R	Tot Bin:2	
R_Nom.Val:	24.890 Ω	
Max: 25.890	Ω+: 4.02%	
Min : 23.890	Ω- : 4.02%	
Q_Max: .1000		
Q_Min :- .1000		

Sort Type

Background Depending on the measurement mode, items can be sorted by either the primary or secondary measurements.

- Move the cursor to SORT BY in the Bin menu.

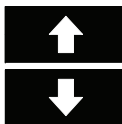

SORT BY R

- Press F3 to switch from primary or secondary sorting.



R↔Q, C↔D, C↔R, L↔Q

Bin Number

Background Up to 13 sorting bins can be configured, with a minimum of 1 bin.

- Move the cursor to TOT_BIN in the Bin menu.

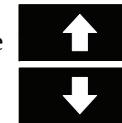

TOT BIN:

- Use the number pad to enter the amount of sort bins.

10 bins

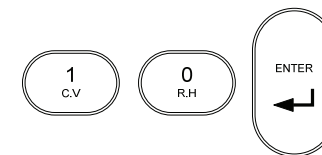

Set Nominal Value

Background Depending on the measurement mode, a nominal value can be set. The nominal value unit depends on the measurement type, see Sort Type, page 63.

- Move the cursor to Nom.Val in the Bin menu.

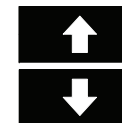

Nom.Val:

- Use the number pad to enter a nominal value for the current sort bin.

For example:
20 Ω.

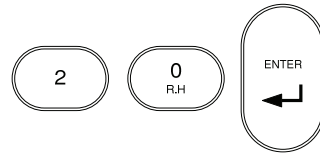

Set Max/Min Absolute Limit

Background The maximum and minimum absolute limits of the current bin can be set. The limit units depend on the measurement type, see Sort Type, page 63.

Panel operation 1. Move the cursor to MAX to set the absolute maximum limit.

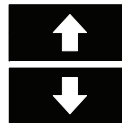

MAX:

2. Use the number pad to enter the maximum absolute value for the current sort bin.

For example:
20 Ω.

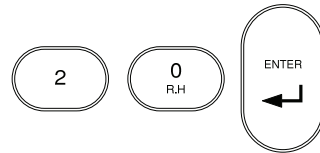

3. Repeat the above procedure for MIN.

Set Max/Min Percentage Limit

Background The maximum and minimum limits of the current bin can be set as a percentage of the nominal value. The limit units depend on the measurement type, see Sort Type, page 63.

Panel operation 1. Move the cursor to +% to set the positive percentage limit.

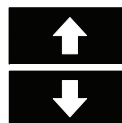

+

2. Use the number pad to enter the maximum percentage value for the current sort bin.

For example:
10%.

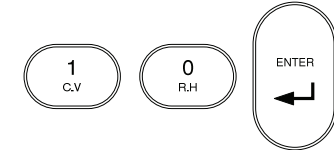

3. Repeat the above procedure for -%.

Set Max/Min Secondary Measurement Limits

Background The absolute maximum and absolute minimum limits of the secondary measurements can also be set.

Panel operation 1. Move the cursor to X_MAX, where X is the secondary measurement item.

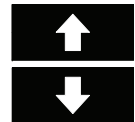

Q_MAX:

2. Use the number pad to enter the maximum value for the current sort bin.



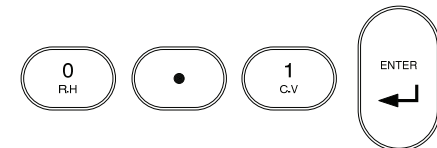

For example:
0.1000



3. Repeat the above procedure for X_MIN. Ensure that MIN is smaller than or negative compared to MAX.

Clear Bins

Background All the bin settings can be cleared for all the bins.

- Panel operation**
1. Press NEXT BIN until BIN1 is the current bin. 
 2. Move the cursor to SORT BY in the Bin menu. 

SORT BY R
 3. Press F1 to clear all the bin settings. 
 4. Press F2(YES ->) to confirm the clear or press F1(NO->) to cancel.
NO ->
Or
YES->



Note Bin settings can only be cleared from Bin1.

Exit Set Bin Menu

- Panel operation**
1. Press EXIT at any time to exit the Bin Set menu. 

Bin Summary Menu

Bin Summary Menu Overview

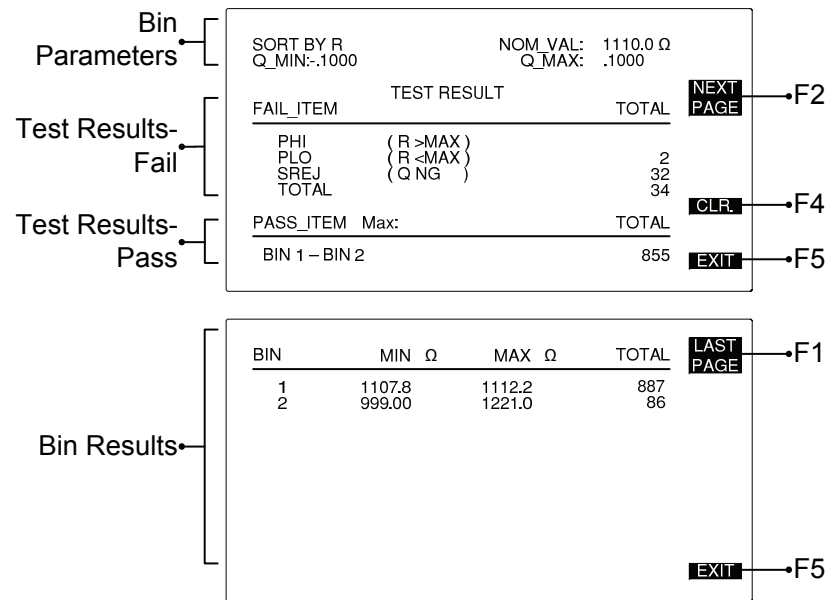

Bin Parameters Shows the basic bin parameters used for the bin sorting.
 SORT BY Displays what measurement was used.
 NOM_VAL Displays the nominal value
 *_MIN Displays the secondary measurement sort limits.
 *_MAX

Test Results- Fail Shows all the failed test results. Any tests that failed bin sorting will appear here.

PHI	Indicates that a test result is greater than the maximum limit. PHI= Primary Hi
PLO	Indicates that a test result is less than the minimum limit. PLO = Primary Lo
SREJ	The secondary limit is out of range (NG). SREJ = Secondary Rejection
TOTAL	Displays the total amount of failed test results.

Test Results- Pass Shows the total amount of passed results.

Bin1-Bin2	Displays the bin range and the total amount of passed test results.
-----------	---

Bin Results Shows the results for each Bin.

BIN	Shows the Bin number
MAX X	Displays the maximum limit for each bin
MIN X	Displays the minimum limit each bin.
TOTAL	Displays the total results for each bin.

Menu Keys

NEXT PAGE

Goes to the next results page.

LAST PAGE

Goes to the previous results page.

CLR.

Clears the results.

EXIT

Exits the Bin Summary menu.

Bin Summary/Results

Background After the bins have been set up (page 61) and sorting has been completed (page 55) the measurement results/summary can be shown.

Panel Operation 1. Use the arrow menu keys (F1/F2) to move the cursor to BIN SUM.

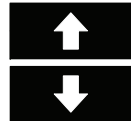

BIN SUM

2. Press SET to enter the BIN SUM menu.



3. The BIN SUM menu appears

SORT BY R		NOM_VAL: 1110.0 Ω	
Q_MIN:-.1000		Q_MAX: .1000	
FAIL_ITEM	TEST RESULT	TOTAL	NEXT PAGE
PHI	(R >MAX)		
PLO	(R <MAX)	2	
SREJ	(Q NG)	32	
TOTAL		34	CLR.
PASS_ITEM Max:		TOTAL	
BIN 1 – BIN 2		855	EXIT

4. Press NEXT PAGE or LAST PAGE to navigate the result pages.



- 5. To clear the test results, press CLR followed by F3 (YES->) to confirm.

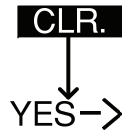

- 6. Press EXIT to exit the bin summary results.

EXIT

RS232 REMOTE

The LCR-821 (LCR-816/817/819 as options) includes RS232C remote connectivity. With the RS232 VIEWER software, the LCR meter can be remotely controlled and all test results can be saved to a PC.

LCR Setup	RS232 Settings.....	73
LCR Viewer	LCR VIEWER Display Overview.....	74
	LCR Viewer Connection and File Settings	75
	LCR Viewer File Settings.....	78
	LCR Viewer Remote Measurement	80
	View Data.....	81
Terminal Connection	Configure Terminal Connection.....	84

LCR Setup

RS232 Settings

Background RS232 must first be enabled on the LCR-800 before trying to connect with a PC.

- Panel operation** 1. From the main menu, press MENU, SORT AND RS232.



2. Press F1 to turn the RS232 interface ON or F2 to turn RS232 OFF.



OR



3. RS232 status will be shown on the display.

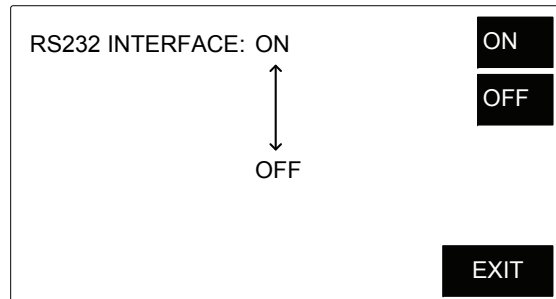

4. Press EXIT to return to the main menu.



LCR Viewer

LCR VIEWER Display Overview

Background LCR-Viewer mimics the LCR-800 series front panel and operates in a similar manner.

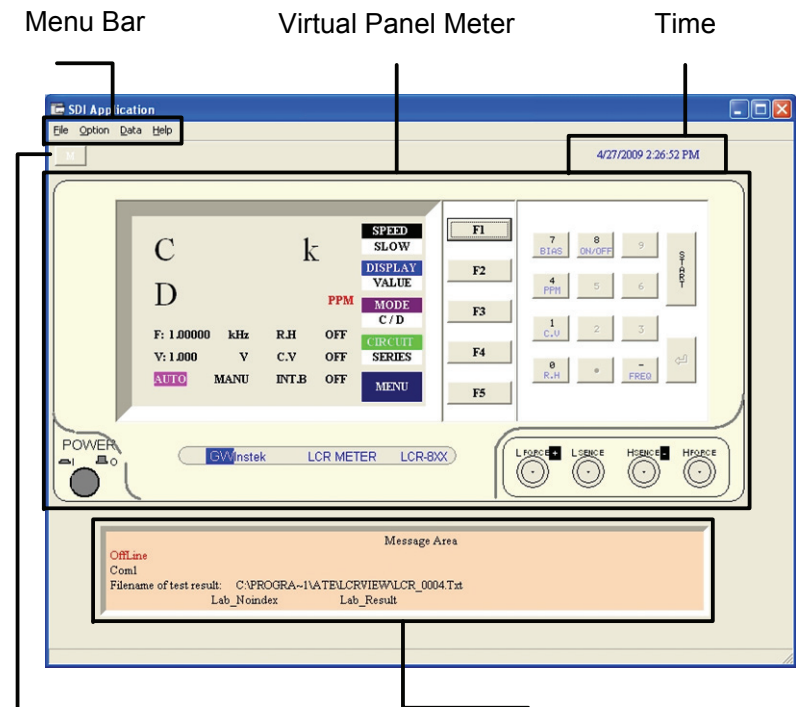

Message Display Key

Message Area

Menu Bar Configures all PC settings, connection settings and shows data results.

Virtual Panel Meter Simulates the LCR-800 series front panel.

Time The current time, used to tag test results.

Message Area	The message area displays the current status of connection, results, files saved and restored.
Message Display Key	The Message Display Key turns the Message Area on/off.

LCR Viewer Connection and File Settings

Background	Before LCR Viewer can be used the connection settings and file settings must be set appropriately. Please ensure LCR Viewer has been installed.
------------	---

- | | | |
|---------------------|---|---------|
| Connection Settings | 1. Connect the LCR meter to the PC with an RS232 cable. | |
| | 2. Ensure the LCR-800 is set to manual (single) measurement mode. | Page 43 |
| | 3. Ensure RS232 has been enabled on the LCR meter. | Page 73 |
| | 4. Run the LCR Viewer program. | |
| | 5. Go to the <u>O</u> ption→Settings menu. | |
| | 6. The Settings panel appears. | |

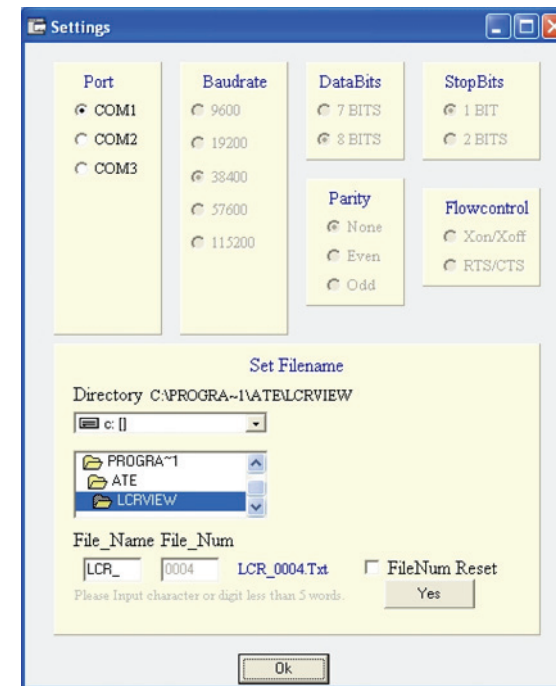

- Choose the COM port. Please see the Windows Device Manager for the applicable COM port setting.
 - Choose the baud rate. (Default 38400)
 - Left click OK to confirm the connection settings.
-
- When the connection settings are completed successfully, the LCR-800 display will show RS232 ONLINE.



Note

DataBits, StopBits, Parity and Flowcontrol cannot be edited.



Note

All file menus (File, Option, Data, Help) are restricted in Auto mode. To change to manual mode see page 43 or 80 to change to Manual mode manually or remotely.

LCR Viewer File Settings

Background

The LCR Viewer file system stores 10000 test results per file. The files are comprised of the file name identifier and file number identifier.

LCR_0001.txt	1	file name identifier
1 2 3	2	file number identifier
	3	TXT File extension

The file name identifier consists of 4 user-defined characters. The file number identifier is incremented per 10000 test results. If LCR Viewer is terminated before 10000 test results, the data will be saved and then the next file will start anew. The file number identifier starts at 0001 and increments to a maximum of 9999. The file number identifier cannot be user-defined, but can be reset to 0001.

	File Name Identifier	File Number Identifier	
Test Result	File_Name	File_Num	Filename
1~10000	LCR_	0001	LCR_0001.txt
10001~20000	LCR_	0002	LCR_0002.txt
99980001~99990000	LCR_	9999	LCR_9999.txt

1. Ensure the LCR-800 is set to manual (single) measurement mode. Page 80
2. Go to the Option→Settings menu.

File Settings

3. Choose a drive and directory from the drop down selections.
4. Type a file name identifier in the File_Name panel. LCR_ is the default.
5. Check FileNum Reset if you want the file number identifier to be reset to 0001. Then left-click Yes to confirm.

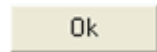
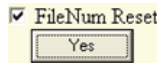
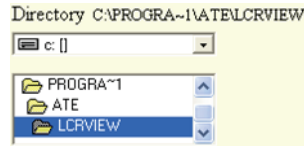

Confirm Settings

6. Left click OK to confirm the connection and file settings.



Note

All file menus (File, Option, Data, Help) are restricted in Auto mode. To change to manual mode see page 80 to change to Manual mode remotely.

LCR Viewer Remote Measurement

Background

The LCR Viewer Software mimics the LCR-800 meter front panel. Remote operation is identical. To operate any of the controls remotely, a mouse must be used. A keyboard cannot be used. Operation of LCR Viewer is the same as the operation of the LCR meter.



Note

If a button is grayed-out, the key or operation is not currently selectable.

Operation

1. To choose a menu key, click any F1~F5 menu key.
2. To use a number key, click any of the number keys.
3. To choose an operating mode, right click the Start button and click the AUTO/MANU pop-up button.
4. To run a measurement in manual mode, click the start button.
5. To stop measuring in Auto mode, right click the start button and click the AUTO/MANU pop-up button.

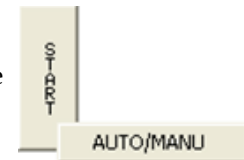
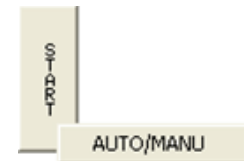

- To exit LCR Viewer, press the POWER button or go to the File → Exit menu.



- To turn the message area on or off press the Message button.



View Data

Background Up to 10000 test results are stored in each file. Each test result is stored as comma separated variables in a text file. Each test result stores the test number, mode, primary and secondary measurements and the time.

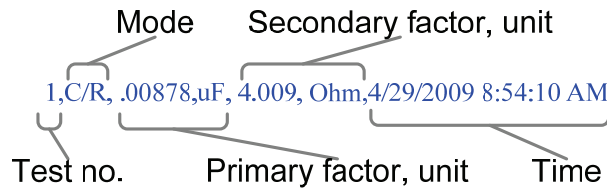

For more information on the way the files store test results see page 78.

- | | | |
|-----------|--|---------|
| | 1. Ensure the LCR-800 is set to manual (single) measurement mode. | Page 80 |
| Operation | 2. To view the test result data, go to the <u>D</u> ata → result menu. | |
| | 3. The test results appear in the data window. | |

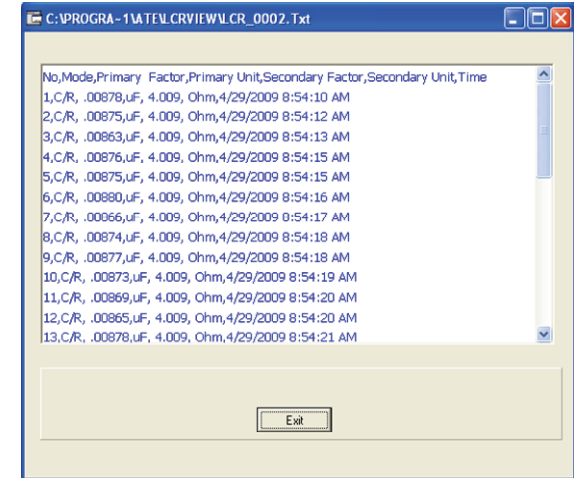

- To exit the data window, click Exit.



Note All file menus (File, Option, Data, Help) are restricted in Auto mode. To change to manual mode see page 80 to change to Manual mode remotely.

View Help

Background The Help menu is to view the software version and copyright information

- | | | |
|-----------|---|---------|
| Operation | 1. Ensure the LCR-800 is set to manual (single) measurement mode. | Page 80 |
| | 2. Go to the <u>H</u> elp → About menu. | |
| | 3. The About information appears | |



4. Press OK to exit.

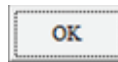

Note

All file menus (File, Option, Data, Help) are restricted in Auto mode. To change to manual mode see page 80 to change to Manual mode remotely.

Exit LCR Viewer

Operation

1. Press the POWER software button or go to File→Exit when in manual mode.

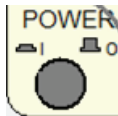

Note

All file menus (File, Option, Data, Help) are restricted in Auto mode. To change to manual mode see page 80 to change to Manual mode remotely.

Terminal Connection

Configure Terminal Connection

Background To connect the LCR-800 to a terminal program, follow the instructions below.

Connection Settings

1. Connect the LCR meter to the PC with an RS232 cable.

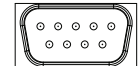

2. Ensure the LCR-800 is set to manual (single) measurement mode.

Page 43

3. Ensure RS232 has been enabled on the LCR meter.

Page 73

4. Open a terminal program such as MTTY (Multithreaded TTY).

5. Check the COM port settings on the PC. In Windows use Device Manager. Go to the Control Panel→System→Hardware tab to see the COM port settings.

Terminal
Initiation

6. Connect to the terminal program with the following configuration settings:
 - COM port (as per PC)
 - Baud rate- 38400
 - Data bits- 8
 - Stop bit- 1
 - Parity- none
 - Flow control- none
7. From the terminal program enter the following commands, with ^END^M or ^J^M as the terminal characters.

Terminal command: COMU?

LCR Return: COMU:ON..

Terminal command: COMU:OVER

LCR Return: COMU:OVER
8. The LCR-800 will display RS232 ONLINE when the connection is successful.

RS232 ONLINE

9. See the Programming chapter for remote programming details. Page 87

- Disconnection
10. To disconnect remote control send the following command with ^END^M or ^J^M as the terminal character.

Terminal command: COMU:OFF.

LCR Return: COMU:OFF.

P PROGRAMMING

Command overview lists all the LCR-800 commands and command queries. The command syntax section shows you the basic rules you have to apply when using commands.

Command Syntax

Command Background	There are a number of different instrument commands and queries. A command sends instructions or data to the LCR meter and a query receives data or status information from the LCR meter. Measurements are automatically sent when a measurement is made in manual or automatic mode.
Command Types	
Command	Two or more commands separated by a colon (:) with/without a parameter Example MEMO:STOR 100.<^END^M>
Query	A query is a compound command followed by a question mark (?). A parameter (data) is returned. Example SORT:NOMV?<^END^M>
Measurement	Returns measurement data. Can be manually or automatically updated. Example MAIN:PRIM 32.705<^END>

Command forms Commands and queries can be written in either ASCII or hexadecimal.

Below are examples of ASCII and hexadecimal commands

ASCII **SORT:NOMV +32.0000<_END^M> or <_AJ^M>**

Hex **53 4F 52 54 3A 4E 4F 4D 56 20 2B 33 32 2E 30 30 30 30 0A 0D**

Command format **MAIN:PRIM 32.705<^END>** 1: command header
 2: single space
 3: parameter
 4: message terminator

Parameter	Type	Description	Example
	<string>	Character string	SLOW
	<NR1>	Integers	0, 1, 2, 3
	<variable>	number data	0.1, 3.14, 8.5
Message terminators	<NL^END> or <NL^J> <CR^M>	New line or ASCII line feed character (HEX 0A) Carry return character (Hex 0D)	
Input Output value differences		The format of the input and output values differ somewhat when dealing with positive values. The total amount of characters used for each variable depends on the command/query.	
		Number	ASCII
		HEX	
Input	1.0000	+1.0000	2B 31 2E 30 30 30 30
Output	1.0000	sp1.0000	20 31 2E 30 30 30 30
Input	-1.0000	-1.0000	2D 31 2E 30 30 30 30

Output -1.0000 -1.0000 2D 31 2E 30
 30 30 35

As can be seen above, positive input numbers use the ASCII “+” whilst the output will use a “sp” space character to represent a positive number. Negative numbers are identical for both input and output.

Combining Commands

Commands and queries can be combined to form a large continuous command. Each command must be separated with a line feed character < ^END> (or < ^J>). The combined command must be terminated with a line feed and carriage return character < ^END^M> (or < ^J^M>). All messages and parameters will be returned sequentially with a line feed character (< ^END> (or < ^J>) separator).

ASCII example

MAIN:FREQ 1.0000< ^END> (or < ^J>) MAIN:VOLT 1.000< ^END> (or < ^J>) MAIN:SPEE:FAST< ^END^M> (or < ^J^M>)

Hex example

4D 41 49 4E 3A 46 52 45 51 20 31 2E 30 30 30 30 30 0A
 4D 41 49 4E 3A 56 4F 4C 54 20 31 2E 30 30 30 0A 4D
 41 49 4E 3A 55 50 45 45 3A 46 41 53 54 0A 0D (Hex format)

Commands

SPEED 91
 DISPLAY 91
 MODE 92
 CIRCUIT 93
 FREQUENCY 94
 VOLTAGE 94
 AUTO/MANU 95
 START 96
 RANGE HOLD 96
 C.V 97
 BIAS 97
 INT.B 98
 EXT.B 98
 PPM 99
 OPEN 100
 SHORT 100
 NOM.VAL 100
 RECALL 101
 STORE 102
 AVERAGE 103
 RECALL CALIBRATION 103
 BAUD RATE 104
 MODEL NUMBER 104
 ON-LINE 105
 MEASURE HOLD 105
 MEASURE RECOVER 105
 LEVEL DISPLAY 106
 PRIMARY FACTOR 106
 PRIMARY OVER 107
 PRIMARY OVER SECONDARY OVER 107
 SECONDARY FACTOR & PRIMARY UNIT 107
 SECONDARY OVER & PRIMARY UNIT 108
 SECONDARY FACTOR, PRIMARY UNIT, SECONDARY UNIT 109
 SECONDARY OVER, PRIMARY UNIT, SECONDARY UNIT 109
 INITIATION HAS FINISHED (Initiate) 110
 OFF LINE 110

SPEED Command/Query

The speed command sets the measurement speed of the instrument. The faster the measurement speed the lower the accuracy. This command also queries the current measurement speed.

Syntax MAIN:SPEE:<string><^END^M>or<^J^M>

Parameter

<string>	Speed
SLOW	Slow
MEDI	Medium
FAST	Fast

Example MAIN:SPEE:SLOW<^END^M>
Set the measurement speed to slow.

Query Syntax MAIN:SPEE?<^END^M>or<^J^M>

Return String

<string>	Speed
MAIN:SPEE:SLOW<^END>	Slow
MAIN:SPEE:MEDI<^END>	Medium
MAIN:SPEE:FAST<^END>	Fast

Query Example MAIN:SPEE?<^END^M>
MAIN:SPEE:MEDI<^END>
Medium measuring speed is returned.

DISPLAY Command/Query

The display command sets the displayed measurement as a value or as an offset from a nominal value (Delta or Delta%)

Syntax MAIN:DISP:<string><^END^M>or<^J^M>

Parameter

<string>	Display
VALU	Unit Value
DELP	Delta %
DELT	Delta

Example MAIN:DISP:VALU<^END^M>
Set the display to Value

Query Syntax MAIN:DISP?<^END^M>or<^J^M>

Return String

<string>	Display
MAIN:DISP:VALU<^END>	Value
MAIN:DISP:DELP<^END>	Delta %
MAIN:DISP:DELT<^END>	Delta

Query Example MAIN:DISP?<^END^M>
MAIN:DISP:VALU<^END>
Currently the display is set at value.

MODE Command/Query

The mode command sets the measurement mode of the LCR-800.

Syntax MAIN:MODE:<string><^END^M>or<^J^M>

Parameter

<string>	Primary Measurement	Secondary Measurement
RQ	Resistance	Quality factor
CD	Capacitance	Dissipation factor
CR	Capacitance	Resistance
LQ	Inductance	Quality factor
LR*	Inductance	Resistance
ZQ*	Impedance	Angle

*For the LCR-821 only

Example	MAIN:MODE:RQ<^END^M> Sets the mode to R/Q (Resistance/Quality factor)
Query Syntax	MAIN:MODE?<^END^M>or<^J^M>
Return String	
<string>	Current measurement mode
MAIN:MODE:RQ<^END>	R/Q
MAIN:MODE:CD<^END>	C/D
MAIN:MODE:LQ<^END>	L/Q
MAIN:MODE:LR<^END>	L/R
MAIN:MODE:ZQ<^END>	Z/Q
Query Example	MAIN:MODE?<^END^M> MAIN:MODE:RQ<^END> Returns the current measurement mode as R/Q

CIRCUIT Command/Query

The mode command sets the equivalent circuit to series or parallel.

Syntax	MAIN:CIRC:<string><^END^M>or<^J^M>
Parameter	
<string>	Equivalent Circuit
SERI	Series
PARA	Parallel
Example	MAIN:CIRC:SERI<^END^M> Sets the equivalent circuit to series
Query Syntax	MAIN:CIRC?<^END^M>or<^J^M>
Return String	
<string>	Equivalent circuit
MAIN:CIRC:SERI<^END>	Series

MAIN:CIRC:PARA<^END>	Parallel
Query Example	MAIN:CIRC?<^END^M> MAIN:CIRC:PARA<^END> Returns a parallel equivalent circuit as the current setting.

FREQUENCY Command/Query

Set or queries the test frequency.

Syntax	MAIN:FREQ <variable><^END^M>or<^J^M>
Parameter	
<variable>	Frequency (kHz)
0.01200~100.000	(7 characters, including a decimal) 12 Hz~100kHz
Example	MAIN:FREQ 0.01200<^END^M> Sets the frequency to 12Hz (0.012 kHz)
Query Syntax	MAIN:FREQ?<^END^M>or<^J^M>
Return String	
<string>	Frequency
MAIN:FREQ < variable ><^END> (<variable >=0.01200~100.000)	Returns the test frequency in kHz.
Query Example	MAIN:FREQ?<^END^M> MAIN:FREQ 0.01200<^END> Returns the current test frequency in kHz (12 Hz).

VOLTAGE Command/Query

Set or queries the test signal voltage.

Syntax	MAIN:VOLT < variable ><^END^M>or<^J^M>
Parameter	
< variable >	Test signal voltage

0.005~1.275	(5 characters, including a decimal)	5mV~1.275
Example	MAIN:VOLT 0.005<^END^M> Sets the test signal voltage to 5mV.	
Query Syntax	MAIN:VOLT?<^END^M>or<^J^M>	
Return String	<string> Voltage	
	MAIN:VOLT :< variable ><^END>	Returns the test voltage.
	(<variable >= 0.005~1.275)	
Query Example	MAIN:VOLT?<^END^M> MAIN:VOLT 0.005<^END> Returns the test voltage (5mV)	

AUTO/MANU Command/Query

Sets automatic or manual measurement mode.

Syntax	MAIN:TRIG:<string><^END^M>or<^J^M>	
Parameter	<String> Test mode	
	AUTO	Automatic mode
	MANU	Manual mode
Example	MAIN:TRIG:MANU<^END^M> Sets the measuring mode to manual	
Query Syntax	MAIN:TRIG?<^END^M>or<^J^M>	
Return String	<string> Voltage	
	MAIN:TRIG:AUTO<^END>	Returns automatic mode
	MAIN:TRIG:MANU<^END>	Returns manual mode
Query Example	MAIN:TRIG?<^END^M> MAIN:TRIG:AUTO<^END>	

Returns Auto mode as the current measurement mode.

START Command

Starts a measurement in manual mode.

Syntax	MAIN:STAR<^END^M>or<^J^M>	
Example	MAIN:STAR<^END^M> Starts the measurement	

RANGE HOLD Command/Query

Turns range hold on or off or queries the range hold status.

Syntax	MAIN:R.H.:<string><^END^M>or<^J^M>	
Parameter	<String> Range hold	
	OFF.	Off
	ON..	On
Example	MAIN:R.H.:OFF.<^END^M> Turn range hold off	
Query Syntax	MAIN:R.H.?<^END^M>or<^J^M>	
Return String	<string> Range Hold status	
	MAIN:R.H.:OFF.<^END>	Range hold is off
	MAIN:R.H.:ON.<^END>	Range hold is on
Query Example	MAIN:R.H.?<^END^M> MAIN:R.H.:ON.<^END> Returns the Range Hold status (On)	

C.V Command/Query

Turns Constant Voltage on or off. Queries the constant voltage status.

Syntax MAIN:C.V.:<string> <^END^M>or<^J^M>

Parameter

<String> Constant Voltage

OFF. Off

ON.. On

Example MAIN:C.V.:OFF.<^END^M>

Turns Constant Voltage off

Query Syntax MAIN:C.V.?.<^END^M>or<^J^M>

Return String

<string> Constant Voltage status

MAIN:C.V.:OFF.<^END> Constant voltage is off

MAIN:C.V.:ON..<^END> Constant Voltage is on

Query Example MAIN:C.V.?.<^END^M>

MAIN:C.V.:OFF.<^END>

Returns the Constant Voltage status (Off)

BIAS Query

Queries the Bias status.

Query Syntax MAIN:BIAS?<^END^M>or<^J^M>

Return String

<string> Bias Status

MAIN:INTB:ON..<^END> Internal Bias is on

MAIN:INTB:OFF.<^END> Internal Bias is off

MAIN:EXTB:ON..<^END> External Bias is on

MAIN:EXTB:OFF.<^END> External Bias is off

Query Example MAIN:BIAS?<^END^M>
MAIN:EXTB:ON..<^END>
Returns the Bias Status (External Bias is on).

INT.B Command/Query

Sets and queries the internal bias.

Syntax MAIN:INTB:<string><^END^M>or<^J^M>

Parameter

<String> Internal Bias

OFF. Off

ON.. On

Example MAIN:INTB:OFF.<^END^M>

Turn Internal Bias off.

Query Syntax MAIN:INTB?<^END^M>or<^J^M>

Return String

<string> Internal Bias Status

MAIN:INTB:OFF.<^END> Off

MAIN:INTB:ON..<^END> On

Query Example MAIN:INTB?<^END^M>

MAIN:INTB:OFF.<^END>

Returns the Internal Bias status (Off).

EXT.B Command/Query

Sets and queries the External Bias.

Syntax MAIN:EXTB:<string><^END^M>or<^J^M>

Parameter

<String> External Bias

OFF. Off

ON.. On

Example	MAIN:EXTB:OFF.<^END^M> Turn External Bias off.
Query Syntax	MAIN:EXTB?<^END^M>or<^J^M>
Return String	
<string>	External Bias status
MAIN:EXTB:OFF.<^END>	Off
MAIN:EXTB:ON.<^END>	On
Query Example	MAIN:EXTB?<^END^M> MAIN:EXTB:ON.<^END> Returns the External Bias status (On).

PPM Command/Query

Turns PPM on or off for Dissipation (D) or Quality factor (Q) measurements.

Syntax	MAIN:PPM.:<string><^END^M>or<^J^M>
Parameter	
<String>	PPM
OFF.	Off
ON..	On
Example	MAIN:PPM.:OFF.<^END^M> Turns PPM off.
Query Syntax	MAIN:PPM.?<^END^M>or<^J^M>
Return String	
<string>	PPM status
MAIN:PPM.:OFF.<^END>	Off
MAIN:PPM.:ON.<^END>	On
Query Example	MAIN:PPM.?<^END^M> MAIN:PPM.:ON.<^END> Returns PPM status (On).

OPEN Command

This command will perform an open circuit calibration. A return string will indicate if the calibration was successful or not.

Syntax	OFFS:OPEN<^END^M>or<^J^M>
Return String	
<string>	Open calibration attempt
OPEN:OK<^END>	Successful
OPEN:FAIL<^END>	Failure
Example	OFFS:OPEN<^END^M> OPEN:OK<^END> Returns the open circuit calibration attempt (Successful).

SHORT Command

This command will perform a closed (short) circuit calibration. A return string will indicate if the calibration was successful or not.

Syntax	OFFS:SHOR<^END^M>or<^J^M>
Return String	
<string>	Short calibration attempt
SHOR:OK<^END>	Successful
SHOR:FAIL<^END>	Failure
Example	OFFS:SHOR<^END^M> SHOR:OK<^END> Returns the closed circuit calibration attempt (Successful).

NOM.VAL Command/Query

Sets or queries the nominal value. The nominal value unit depends on the measurement mode.

Syntax	SORT:NOMV<variable><^END^M>or<^J^M>
--------	-------------------------------------

Parameter		
< variable >		Nominal Value
-XXXXXXXX ~ +XXXXXXXX	Must be any 8 digit character including a decimal place and signage (- or +).	+XXXXXXXX~-XXXXXXXX (Mode dependant)
Example	SORT:NOMV -0.12345<^END^M> Sets the nominal value to -0.12345	
Query Syntax	SORT:NOMV?<^END^M>or<^J^M>	
Return String		
<string>		Nominal Value
SORT:NOMV < variable ><^END> (<variable >=any 8 digit number)		Returns the nominal value.
Query Example	SORT:NOMV?<^END^M> SORT:NOMV 0.00200<^END> Returns the nominal value 2Ω.	

RECALL Command/Query

Recall settings from one of 100 memory slots.

Syntax	MEMO:RECA <variable><^END^M>or<^J^M>	
Parameter		
<variable>		Memory slot
1.00-100.	(integer values)	1-100
 Note	Ensure the number has a total of 4 characters. If a number does not use 4 characters, use a "." and "0" to "pad out" the number. Example 10 = 10.0	
Example	MEMO:RECA 100. <^END^M> Recalls saved settings from memory slot 100	
Query Syntax	MEMO:RECA?<^END^M>or<^J^M>	
Return String		

<string>		Memory recall status
MEMO:NUMB <variable><^END> (<variable>= 1 _{sp} ~100) sp=space character		OK. Returns the memory slot used.
MEMO:RECA:EMPT<^END>		Not Ok. The memory slot is empty, therefore no data to recall.
Query Example	MEMO:NUMB?<^END^M> MEMO:NUMB:100<^END> Data was recalled from memory slot 100.	

STORE Command

Stores the current settings to one of 100 memory slots. A return string will indicate the save slot used.

Syntax	MEMO:STOR <variable><^END^M>or<^J^M>	
Parameter		
<variable>		Memory slot
1.00~100.	(integer values)	1-100
 Note	Ensure the number has a total of 4 characters. If a number does not use 4 characters, use a "." and additional zero's (0) to "pad out" the number. Example 10 = 10.0	
Return String		
<string>		Memory save slot
MEMO:STOR <variable><^END> (<variable>= 1 _{sp} ~100) sp=space character		Returns the save slot used.
Example	MEMO:STOR 100.<^END^M> MEMO:STOR 100<^END> Data was saved to memory slot 100.	

AVERAGE Command/Query

Sets the average number from 1~255. The average number indicates how many test samples are used to create an averaged test result.

Syntax SETP: AVER <variable><^END^M>or<^J^M>

Parameter

<variable>	Average number
1.00~255.	(integer values) 1~255

Note Ensure the number has a total of 4 characters. If a number does not use 4 characters, use a “.” and additional zero’s (0) to “pad out” the number. Example 10 = 10.0

Example SETP: AVER 255.<^END^M>
Average is set to 255 samples.

Query Syntax SETP: AVER?<^END^M>or<^J^M>

Return String

<string>	Current average setting
SETP: AVER <variable><^END>	Returns the average number.
(<variable>= 1.00 ~255.)	

Query Example SETP: AVER?<^END^M>
SETP: AVER 255.<^END>
The average number is currently 255.

RECALL CALIBRATION Command

Recalls the calibration settings from memory. A return string indicates if the command was successful.

Syntax STEP: RECA<^END^M>or<^J^M>

Return String

<string>	Recall calibration
RECA: OK<^END>	Successful

Example STEP: RECA<^END^M>or<^J^M>
RECA: OK<^END>
Calibration was recalled successfully

BAUD RATE Command

Sets the baud rate of the RS232 connection.

Syntax COMU: <value><^END^M>or<^J^M>

Parameter

<value>	Baud rate
9600	9600
19.2	19200
38.4	38400
57.6	57600
1152	115200

Return String

<string>	Baud rate
COMU: <value><^END>	Returns the baud rate setting.
<value>= baud rate	

Query Example COMU: 1152<^END^M>
COMU: 1152<^END>
The baud rate is set to 115200.

MODEL NUMBER Query

This query returns the model number of the LCR-800.

Query Syntax COMU: MONO?<^END^M>or<^J^M>

Return String

<string>	Model number
COMU: MONO: 816.<^END>	LCR-816
COMU: MONO: 817.<^END>	LCR-817

COMU:MONO:819.<^END>	LCR-819
COMU:MONO:821.<^END>	LCR-821
Query Example	COMU:MONO?<^END^M> COMU:MONO:816.<^END> The model number is LCR-816

ON-LINE	Query
The On-line function queries the RS232 connection status.	
Query Syntax	COMU?<^END^M>or<^J^M>
Return String	
<string>	RS232 connection
COMU:ON..<^END>	Connection on
COMU:OFF.<^END>	Connection off
Query Example	COMU?<^END^M>> COMU:ON..<^END> The RS232 connection is on.

MEASURE HOLD	Command
The Measure hold command is used to suspend measurement to issue a new command when the LCR meter is busy. When the new command is issued the Measure Recover command can be used to resume measurement.	
Syntax	COMU:HOLD<^END^M>or<^J^M>
Example	COMU:HOLD<^END^M> Measurement is suspended.

MEASURE RECOVER	Command
The Measure Recover command is used to resume measurements after the Measure Hold command has been used.	
Syntax	COMU:RECO<^END^M>or<^J^M>

Example	COMU:RECO<^END^M> Resume measurement. (recover measurement).
---------	---

LEVEL DISPLAY	Command
Displays a menu level on the LCR-800 display. Returns the menu level.	
Syntax	LEVE:<string><^END^M>or<^J^M>
Parameter	
<string>	Menu Level
MAIN	Main display
MENU	menu display
PARA	Setting (Parameter) menu
SORT	Sort (Handler) menu
OFFS	Offset menu.
Return String	
<string>	Menu level
LEVE:MAIN<^END>	Main display
LEVE:MENU<^END>	Menu display
LEVE:PARA<^END>	Setting (Parameter) menu
LEVE:SORT<^END>	Sort (Handler) menu
LEVE:OFFS<^END>	Offset menu.
Example	LEVE:MAIN<^END^M> LEVE:MAIN<^END> Set the display to the main display.

PRIMARY FACTOR	Measurement
Primary factor returns the primary measurement result, sans the measurement unit. This measurement is the first measurement displayed after measurements have been started.	
Return Syntax	MAIN:PRIM <value><^END>

<value>	Test result
Any 7 digit ASCII including <i>sp</i> (+) or – characters and a decimal point.	Primary measurement value
Example	MAIN:PRIM 32.705<^END>
	The primary measurement is 32.705 (primary measurement unit).

PRIMARY OV01 Measurement

Primary OV01 indicates that the primary measurement exceeds the measurement range of the LCR meter. For example: If the impedance of the DUT is less than the measurement range.

Return Syntax	PRIM:OV01<^END>
Example	PRIM:OV01<^END>
	Note, no units are returned

PRIMARY OVER SECONDARY OVER Measurement

When both the primary and secondary factors exceed the range (OVER), OVER will be returned.

Return Syntax	PRIM:OVER<END>
Example	PRIM:OVER<END>
	Note, no units are returned

SECONDARY FACTOR & PRIMARY UNIT Measurement

Returns the secondary measurement results and the primary unit (R/Q C/D L/Q only). This measurement is the second measurement displayed after measurements have been started.

Return Syntax	MAIN:SECO <value><unit1><^END>
<value>	Test Result
Any 6 digit ASCII character including <i>sp</i> (+) or – characters and a decimal point.	Secondary measurement value

<unit1>	Primary unit
nF, pF, uF	nanofarads, picofarads, microfarads
<i>k_{sp}</i> , <i>spsp</i> (<i>sp</i> = space character)	kΩ, Ω
mH, H _{sp}	millihenry, henry

Example	MAIN:SECO .0045nF<^END>
	The secondary measurement is .0045 (D) and nF is the primary measurement unit.

SECONDARY OVER & PRIMARY UNIT Measurement

Secondary Over indicates that the secondary measurement exceeds the measurement range of the LCR meter. The unit returned refers to the primary measurement. Applicable for (R/Q, C/D, L/Q, Z/θ) equivalent circuits.

Return Syntax	SECO:OVER<unit1><^END>
<unit1>	Primary unit
nF, Pf, uF	nanofarads, picofarads, microfarads
<i>k_{sp}</i> , <i>spsp</i> (<i>sp</i> = space character)	kΩ, Ω
mH, H _{sp}	millihenry, henry
Example	SECO:OVER nF<^END>
	The secondary measurement is OVER(exceeds range) and nF is the primary measurement unit.

SECONDARY FACTOR, PRIMARY UNIT, SECONDARY UNIT Measurement

Secondary measurement result is returned along with the primary unit and secondary unit (C/R, L/R only). This measurement is the second measurement displayed after measurements have been started.

Return Syntax	MAIN:SECO <value><unit1><unit2><^END>	
<value>	Test result	
Any 6 digit ASCII character including <i>sp</i> (+) or – characters and a decimal point.	Secondary measurement value	
<unit1>	Primary units	
nF, Pf, uF	nanofarads, picofarads, microfarads	
<unit2>	Secondary units	
k, <i>sp</i>	kΩ, Ω	
Example	MAIN:SECO .0045nFk<^END>	
	The secondary measurement result is .0045 with kΩ as the unit. The primary unit is nF.	

SECONDARY OVER, PRIMARY UNIT, SECONDARY UNIT Measurement

Secondary Over indicates that the secondary measurement exceeds the measurement range of the LCR meter. Applicable for C/R & L/R equivalent circuits with the display set to Value.

Return Syntax	SECO:OVER <unit1><unit2><^END>	
<unit1>	Primary units	
nF, Pf, uF, mH, Hsp (sp=space)	nanofarads, picofarads, microfarads, millihenry, henry	

<unit2>	Secondary units
k, <i>sp</i>	kΩ, Ω
Example	SECO:OVER nFk<^END>
	The secondary measurement result exceeds the range. kΩ is the secondary unit and nF is the primary unit.

INITIATION HAS FINISHED (Initiate) Command

Initiates the RS232 connection. A string is returned when the initiation has been completed.

Syntax	COMU:OVER<^END^M>or<^J^M>	
Return String		
<string>	Menu level	
COMU:OVER<^END>	Connection initiation finished	
Example	COMU:OVER<^END^M> COMU:OVER<^END>	
	Communication initiation has completed. “RS232 ONLINE” will be displayed on the LCR-800 display panel.	

OFF LINE Command

Terminates the RS232 connection. A string is returned when the initiation has been completed.

Syntax	COMU:OFF.<^END^M>or<^J^M>	
Return String		
<string>	RS232 connection	
COMU:OFF.<^END>	Terminated	
Example	COMU:OFF.<^END^M> COMU:OFF.<^END>	
	The RS232 connection has been terminated.	

INTERACE

This chapter describes basic interface aspects of the RS-232 and Handler interfaces.

RS232 Interface Configuration	Configure RS-232 interface.....	112
	Handler interface	114
Signal Characteristics	Signal Overview	116
	Handler Timing.....	119

RS232 Interface Configuration

Configure RS-232 interface

RS-232 configuration	Connector	DB-9, Male
	Baud rate	38400 (default)
	Parity	None
	Data bit	8
	Stop bit	1

Connect the RS-232 cable to the rear panel port: DB-9 male connector.

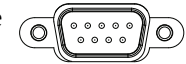

Pin assignment

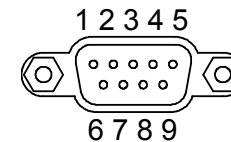

- 1: DCD (Data Carrier Detect)
- 2: RxD (Receive Data)
- 3: TxD (Transmit Data)
- 4: DTR (Data Terminal Ready)
- 5: GND
- 6: DSR (Data Set Ready)
- 7: RTS (Request To Send)
- 8: CTS (Clear To Send)
- 9: No connection

Connection	PC		LCR Meter	
	DB9 Pin	Signal	Signal	DB9 Pin
	2	RxD	TxD	3
	3	TxD	RxD	2
	4	DTR	DSR, DCD	6,1
	5	GND	GND	5
	6,1	DSR, DCD	DTR	4
	7	RTS	CTS	8
	8	CTS	RTS	7

Handler interface

Connection

Connect the male DSUB 25 pin cable to the Handler interface socket.

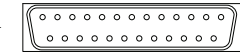

Pin assignment

HANDLER INTERFACE

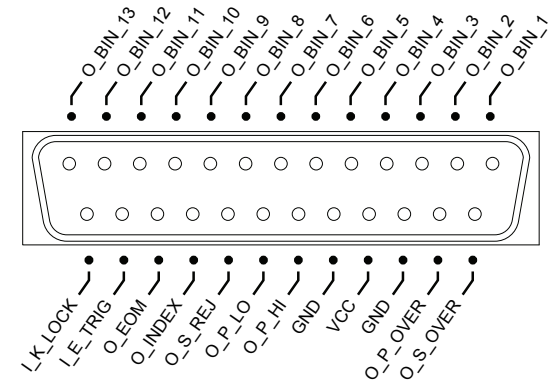

	Signal	Function
Pin1	/O_BIN_1	Go, Assigned BIN 1
Pin2	/O_BIN_2	Go, Assigned BIN 2
Pin3	/O_BIN_3	Go, Assigned BIN 3
Pin4	/O_BIN_4	Go, Assigned BIN 4
Pin5	/O_BIN_5	Go, Assigned BIN 5
Pin6	/O_BIN_6	Go, Assigned BIN 6
Pin7	/O_BIN_7	Go, Assigned BIN 7
Pin8	/O_BIN_8	Go, Assigned BIN 8
Pin9	/O_BIN_9	Go, Assigned BIN 9
Pin10	/O_BIN_10	Go, Assigned BIN 10

Pin11	/O_BIN_11	Go, Assigned BIN 11
Pin12	/O_BIN_12	Go, Assigned BIN 12
Pin13	/O_BIN_13	Go, Assigned BIN 13
Pin14	/O_S_OVER	No-Go/D or Q fail
Pin15	/O_P_OVER	RLC FAIL(O)
Pin16	GND	GROUND
Pin17	VCC	VCC
Pin18	GND	GROUND
Pin19	/O_P_HI	RLC FAIL(O)
Pin20	/O_P_LO	RLC FAIL(O)
Pin21	/O_S_REJ	No-Go/D or Q fail
Pin22	/O_INDEX	Data acquisition over, OK to remove DUT(O)
Pin23	/O_EOM	End of Test(O)
Pin24	/I_E_TRIG	Start Measurement(I)
Pin25	/I_K_LOCK	Panel Lock

Signal Overview

Background	The signal overview section describes the functions and the overall characteristics of the signals used in the handler interface.	
Parameter	Output Signals	
	/O_INDEX	The Index signal will become low when the Analog measurement time has completed. When the Index signal is low, the test component can be replaced with the next component. The signal goes high when the next trigger is active.
	/O_BIN_1 ~ /O_BIN_13	The Bin Go/No-Go signals go active low when a successful comparison has been made. For example if a component is assigned to Bin_1, /O_BIN_1 signal goes low until time T4. All the remaining signals (/O_BIN_2~/O_BIN_13) remain high.
	/O_P_HI	When the primary measurement is higher than the MAX limit, O_P_HI will go low until time T4.
	/O_P_LO	When the primary measurement is lower than the MIN limit, O_P_LO will go low until time T4.
	/O_P_OVER	When the primary measurement is higher or lower than the MAX/MIN, O_P_OVER will go low until time T4.

/O_S_REJ	The /O_S_REJ or /O_S_OVER signal will go low when the secondary measurement is over D_Max or under D_Min, whilst in C/D, R/Q, C/R or L/R mode. The signals will go high at time T4
/O_S_OVER	
/O_EOM	The End of Measurement signal becomes active low when the Bin comparison/assignment has completed. The signal goes high after the next time I_E_TRIG is active low.

Electrical Characteristics

Output Characteristics

Signal	Output Voltage		
	Low	High	Max current
/O_BIN1-BIN13			
/O_S_OVER			
O_S_REJ			
/O_P_OVER			
/O_P_LO	≤0.5V	+5V~+24V*	5mA*
/O_P_HI			
Control Signals			
/O_INDEX			
/O_EOM			

* Pull-up resistors R408~R427 must be replaced to output greater than 5V.

Parameter	Input Signals	
/I_E_TRIG	Measurement start signal. This signal will trigger the LCR-800 to start a measurement when the signal is pulsed for at least 5us. It is triggered by the falling edge of the pulse.	
/I_K_LOCK	The key lock signal disables the panel keys when the signal is low, and enables the panel keys when the signal is high.	

Electrical Characteristics

Input Characteristics

Signal	Input Voltage		Input Current (Low Pull up voltage)	
	Low	High	5V	12V
/I_E_TRIG	≤1V	+5V~15V	5mA	12mA
/I_K_LOCK	≤1V	+5V~15V	5mA	12mA

Handler Timing

Background The handler timing characteristics are described in the timing diagram. Times T1 to T6 are described in the relevant tables.

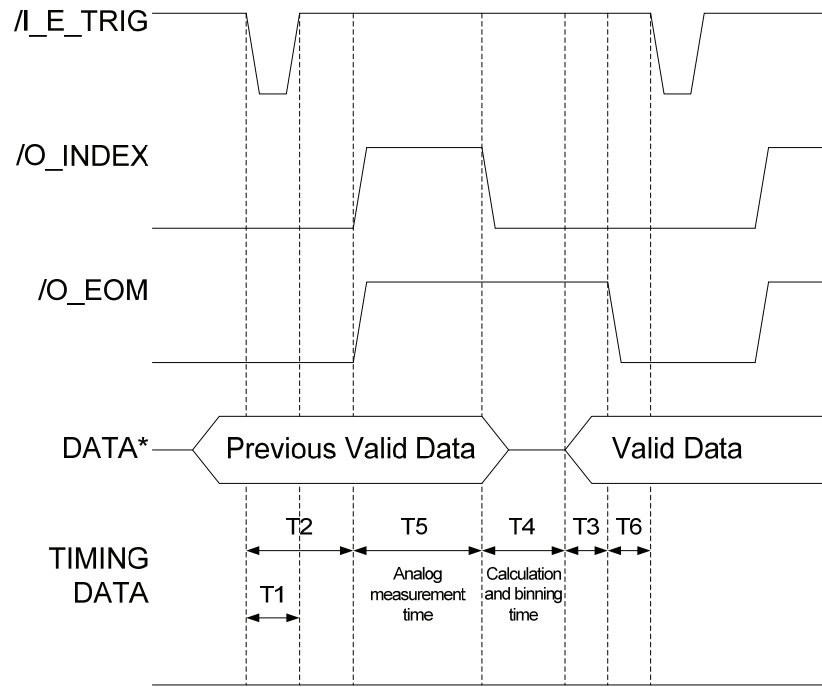

* DATA = /O_BIN_1~13; /O_P_OVER; /O_S_OVER; /O_S_REJ; /O_P_HI; /O_P_LO

Timing Characteristics

Trigger Pulse Width	T1	MIN	MAX
		5us	~
Measurement start delay time	T2	MIN	MAX
		140us	~
/O_EOM Delay Time After Data Output	T3	MIN	MAX
		5us	~
Calculation and binning time	T4	MIN	MAX
		6ms	~

Analog Measurement time	T5	Slow	Medium	Fast	
		0.012kHz	817ms	817ms	817ms
		0.1kHz	901ms	125ms	125ms
		0.12kHz	901ms	105ms	103ms
		1kHz	903ms	59ms	27ms
		10kHz	873ms	53ms	17ms
Trigger Wait Time After /O_EOM Output	T6	Slow	Medium	Fast	
		OFF	2ms	2ms	2ms
		BIN	4ms	4ms	4ms
		VALUE	16ms	16ms	16ms

Binning Accuracy

	Fast	Medium	Slow
LCR_827	0.5%	0.2%	0.1%
LCR_829	0.5%	0.2%	0.1%
LCR_826	0.5%	0.2%	0.1%

F AQ

Q1. What is the correct procedure for Open/Short Zeroing when using the LCR-06A test fixture?

A1. The LCR-06A test fixture is very sensitive and thus must be used correctly.

- For Open Zeroing, make sure that the test fixture wires do not move and that there is nothing in close proximity to the test clips.
- For Short Zeroing ensure the clips are properly shorted. See page 24 for details.

Q2. Why does Short Zeroing fail?

A2. There are two possible reasons that Short Zeroing can fail.

- The test fixture has an open circuit between the wires and terminal.
- Some functions can impede the short test. Ensure Range Hold and Internal/External Bias (R.H and INT.B/EXT.B) are disabled. See pages 40, 39 & 34.

Q3. I cannot see the display clearly.

A3. Use the display contrast control on the rear panel to adjust the contrast.

Q4. When using a terminal program I cannot execute a command.

A4. Make sure the correct terminal characters are used. For example use "CTRL J" "CTRL M" as the <^J^M> message terminator in a terminal session.

For more information, contact your local dealer or GW Instek at www.gwinstek.com / marketing@goodwill.com.tw.

APPENDIX

Fuse Replacement

- Step 1. Disconnect the power cord and then remove the fuse socket using a flat screwdriver.

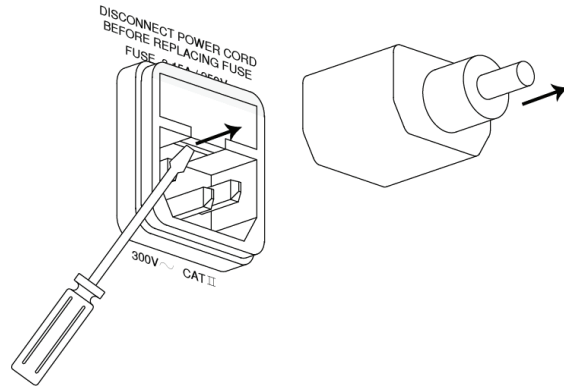

2. Replace the fuse in the holder.

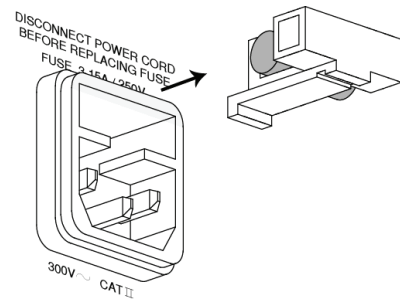

Rating 5TT 3A/250V

Circuit Theory and Formula

Series/Parallel circuit models

Background Below are the circuit diagrams and formulas describing the six types of series and parallel equivalent circuits: Capacitive, Inductive and Resistive. The formulas for all the primary and secondary measurement types are also shown.

Capacitance (C)

Series diagram

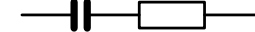

Series formula

$$C_S = C_P(1 + D^2)$$

D=dissipation factor

Parallel diagram

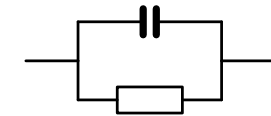

Parallel formula

$$C_P = \frac{C_S}{(1 + D^2)}$$

D=dissipation factor

Inductance (L)

Series diagram



Series formula

$$L_S = \frac{L_P}{\left(1 + \frac{1}{Q^2}\right)}$$

Q=quality factor

Parallel diagram

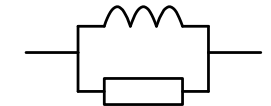

Parallel formula

$$L_P = L_S \left(1 + \frac{1}{Q^2}\right)$$

Q=quality factor

Resistance (R)

Series diagram

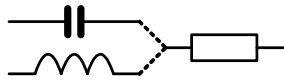

Parallel diagram

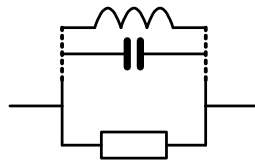

Series formula

$$R_s = \frac{R_p}{(1 + Q^2)}$$

Q=quality factor

Parallel formula

$$R_p = R_s(1 + Q^2)$$

Q=quality factor

Resistance (R) and Conductance (G = 1/R) Formula

Background

Resistance measures how difficult it is for the electricity to flow between two terminals. Conductance is the reciprocal of Resistance and measures how easily the electricity flows.



Note

Conductance is only shown for its relation to Resistance, Conductance is not a measurable feature of the LCR-800 series.

Type

Resistance

Conductance

- Series Resistance R_s
- Parallel Resistance R_p
- DC Resistance R_{dc}
- Parallel Conductance $G_p (= 1/R_p)$

Formula

$$R = \frac{V}{I} = \frac{1}{G} = Z_s - jX \quad G_p = \frac{I}{V} = \frac{1}{R} = Y_p - jB$$

$$= Z_s - j\omega L = Z_s + \frac{j}{\omega C} \quad = Y_p - j\omega C = Y_p + \frac{j}{\omega L}$$

$$|Z_s| = \sqrt{(R^2 + X^2)} \quad |Y_s| = \frac{GB}{\sqrt{(G^2 + B^2)}}$$

$$|Z_p| = \frac{RX}{\sqrt{(R^2 + X^2)}} \quad |Y_p| = \sqrt{(G^2 + B^2)}$$

$$R_s = |Z| \cos \theta \quad G_p = |Y| \cos \theta$$

Capacitance (C) Formula

Background	Capacitance measures the amount of electronic charge stored between two terminals.	
Type	• Series Capacitance C_S • Parallel Capacitance C_P	
Formula	$Z_S = R - \frac{j}{\omega C}$ $Q = \frac{1}{\omega C_S R_S}$ $D = \omega C_S R_S$	$Y_P = G + j\omega C$ $Q = \omega C_P R_P, D = \frac{G_P}{\omega C_P}$

Inductance (L) Formula

Background	Inductance measures the amount of magnetic flux generated in certain electrical current.	
Type	• Series Inductance L_S • Parallel Inductance L_P	
Formula	$Z_S = R + j\omega L$ $Q = \frac{\omega L_S}{R_S}, D = \frac{R_S}{\omega L_S}$	$Y_P = G - \frac{j}{\omega L}$ $Q = \frac{R_P}{\omega L_P}, D = \omega L_P G_P$

Reactance (X) and Susceptance (B = 1/X) Formula

Background	Reactance measures the imaginary part of Impedance (Z) caused by capacitors or inductors. Susceptance is the reciprocal of Reactance and measures the imaginary part of Admittance (Y), which is the reciprocal of Impedance.	
 Note	Reactance and Susceptance is only shown for their relation to impedance. Reactance and Susceptance are not measurable features of the LCR-800 series.	
Type	Series Reactance (X_S)	Parallel Susceptance (B_P)
Formula	$X = \frac{1}{B} = Z \sin \theta$ $ Z_S = \sqrt{(R^2 + X^2)}$ $ Z_P = \frac{RX}{\sqrt{(R^2 + X^2)}}$ $X_S = Z \sin \theta$	$B = \frac{1}{X} = Y \sin \theta$ $ Y_S = \frac{GB}{\sqrt{(G^2 + B^2)}}$ $ Y_P = \sqrt{(G^2 + B^2)}$ $B_P = Y \sin \theta$

Impedance (Z) and Admittance (Y = 1/Z) Formula

Background Impedance measures the total amount of opposition between two terminals in an AC circuit. Admittance is the reciprocal of Impedance and measures how easily the electricity flows in an AC circuit.

 **Note** Admittance is only shown for its relation to impedance. Admittance is not measurable with the LCR-800 series.

Type	Impedance (Z)	Admittance (Y)
Formula	$Z = \frac{E}{I} = \frac{1}{Y}$ $Z_S = R + jX$ $= R + j\omega L = R - \frac{j}{\omega C}$ $ Z_S = \sqrt{(R^2 + X^2)}$ $ Z_P = \frac{RX}{\sqrt{(R^2 + X^2)}}$ $R_S = Z \cos \theta$ $X_S = Z \sin \theta$	$Y = \frac{I}{E} = \frac{1}{Z}$ $Y_P = G + jB$ $= G + j\omega C = G - \frac{j}{\omega L}$ $ Y_S = \frac{GB}{\sqrt{(G^2 + B^2)}}$ $ Y_P = \sqrt{(G^2 + B^2)}$ $G_P = Y \cos \theta$ $B_P = Y \sin \theta$

Quality factor (Q) and Dissipation factor (D) Formula

Background Both Quality factor and its reciprocal, Dissipation factor, are used for measuring the rate of energy dissipation relative to the measurement frequency.

- Low energy dissipation: high Q, low D
- High energy dissipation: low Q, high D

Type	Quality factor (Q)	Dissipation factor (D)
Formula	$Q = \frac{\omega L_S}{R_S} = \frac{1}{\omega C_S R_S}$ $= \frac{R_P}{\omega L_P} = \omega C_P R_P$ $= \frac{1}{\tan(90 - \theta)^\circ} = \frac{1}{D}$	$D = \frac{R_S}{\omega L_S} = \omega C_S R_S$ $= \frac{G_P}{\omega C_P} = \omega L_P G_P$ $= \tan(90 - \theta)^\circ = \frac{1}{Q}$

Angle (θ) Formula

Background	The Angle (θ) measures the phase on which Impedance (Z), Admittance (Y), Quality factor (Q), and Dissipation factor (D) are measured.	
Type	Angle (θ)	
Formula	$Z_s = R + jX$ $= R + j\omega L = R - \frac{j}{\omega C}$ $Q = \frac{1}{\tan(90 - \theta)^\circ} = \frac{1}{D}$ $R_s = Z \cos \theta$ $X_s = Z \sin \theta$	$Y_p = G + jB$ $= G + j\omega C = G - \frac{j}{\omega L}$ $D = \tan(90 - \theta)^\circ = \frac{1}{Q}$ $G_p = Y \cos \theta$ $B_p = Y \sin \theta$

Accuracy Definitions

Primary Measurement Readout Error Formula	
C	2 counts \pm 0.03%+0.02%[(1+Ka) [#] or (X/Ymax) [#] or (Ymin/X) [#]] (1+ D)(1+Kb+Kc)
R	2 counts \pm 0.03%+0.02%[(1+Ka) [#] or (X/Ymax) [#] or (Ymin/X) [#]] (1+ Q)(1+Kb+Kc)
L	2 counts \pm 0.03%+0.02%[(1+Ka) [#] or (X/Ymax) [#] or (Ymin/X) [#]] (1+ 1 / Q)(1+Kb+Kc)
Z	Ze = Depends on whether the component is a capacitor(C), resistor(R) or inductor(L): Circuit Formula for relevant circuit
C	Ze = 2 counts \pm 0.03%+0.02%[(1+Ka) [#] or (X/Ymax) [#] or (Ymin/X) [#]] (1+ D)(1+Kb+Kc)
R	Ze = 2 counts \pm 0.03%+0.02%[(1+Ka) [#] or (X/Ymax) [#] or (Ymin/X) [#]] (1+ Q)(1+Kb+Kc)
L	Ze=2 counts \pm 0.03%+0.02%[(1+Ka) [#] or (X/Ymax) [#] or (Ymin/X) [#]] (1+ 1 / Q)(1+Kb+Kc)
Secondary Measurement Readout Error Formula	
D(C/D)	2counts \pm 0.0003 + 0.0002[(1+Ka) [#] or (X/Ymax) [#] or (Ymin/X) [#]] (1+ D +D ²)(1+Kb+Kc)
Q(R/Q)	2counts \pm 0.0003 + 0.0002[(1+Ka) [#] or (X/Ymax) [#] or (Ymin/X) [#]] (1+ Q +Q ²)(1+Kb+Kc)
Q(L/Q)	2counts \pm 0.0003 + 0.0002[(1+Ka) [#] or (X/Ymax) [#] or (Ymin/X) [#]] (1+ Q +Q ²)(1+Kb+Kc)
θ (Z/ θ)	$\theta e = (180 / \pi) \times (Ze/100)$
R(C/R)	D \geq 1 2counts + 0.02%[(1+Ka) [*] or (Rx/Rmax) [*] or (Rmin/Rx) [*]] (1+ 1/ D)(1+Kb+Kc)+0.03%
	D \leq 1 2counts + 0.02%[(1+Ka) ^{**} or (Cx/Cmax) ^{**} or (Cmin/Cx) ^{**}] (1+ 1/ D)(1+Kb+Kc)+0.03%

R(L/R)	$Q \leq 1$	2counts + 0.02%[(1+Ka)* or (Rx/Rmax)* or (Rmin/Rx)*] (1+ Q)(1+Kb+Kc)+0.03%
	$Q \geq 1$	2counts + 0.02%[(1+Ka)** or (Lx/Lmax)** or (Lmin/Lx)**] (1+ Q)(1+Kb+Kc)+0.03%

Conditions	#	1. if X>Ymax, please select (X/Ymax) 2. if X<Ymin, please select (Ymin/X) 3. if Ymin ≤ X ≤ Ymax, please select (1+Ka) 4. Ze is impedance error 5. θe is θ error
	*	1. If Rx ≥ Rmax, please select (Rx/Rmax) 2. if Rx ≤ Rmin, please select (Rmin/Rx) 3. if Rmin ≤ Rx ≤ Rmax, please select (1+Ka)
	**	1. If Cx > Cmax, please select (Cx/Cmax) 2. if Cx < Cmin, please select (Cmin/Cx) 3. if Cmin ≤ Cx ≤ Cmax, please select (1+Ka)

Variables	Ka	Constant Voltage factor Constant Voltage On, Ka = 2 Constant Voltage Off, Ka = 0	
	Kb	Test Speed factor Speed = SLOW, Kb = 0 Speed = MEDIUM, Kb = 3 Speed = FAST, Kb = 10	
		Kc	Frequency & RMS Voltage factor (refer to table1&2)
		X	X is value of the component being tested.
	Cx	Value of the component being tested (capacitance)	
	Rx	Value of the component being tested (resistance)	
	Lx	Value of the component being tested (inductance)	
	Cmax	Range constant for Capacitor Max table 3/4	
	Cmin	Range constant for Capacitor Min in table 3/4	
	Rmax	Range constant for Resistor Max in table 3/4	
	Rmin	Range constant for Resistor Min in table 3/4	
	Lmax	Range constant for Inductor Max in table 3/4	
	Lmin	Range constant for Inductor Min in table 3/4	
	Ymax	Range constant for either Capacitor/Resistor or Inductor Max in table 3/4	
	Ymin	Y range constant for either Capacitor/Resistor or Inductor Min in table 3/4	

Table 1
KC (Ranges 1,2,3) Frequency & RMS Voltage factor

Frequency	Voltage			
	$0.03 \leq V < 0.1$	$0.1 \leq V < 0.25$	$0.25 \leq V < 1$	$1 \leq V \leq 1.265$
$0.012 \leq f < 0.03$	35	12	9	7
$0.030 \leq f < 0.1$	30	8	5	3
$0.1 \leq f < 0.25$	25	6	3	2
$0.25 \leq f < 1$	20	5	2	1
1	14	4	1	0
$1 < f \leq 3$	15	5	2	1
$3 < f \leq 6$	15	6	3	2
$6 < f \leq 10$	15	8	5	3
$10 < f \leq 20$	20	10	6	5
$20 < f \leq 50$	30	22	18	15
$50 < f \leq 100$	50	40	35	30
200	Not applicable	80	50	45

f= frequency in kHz.

Table2
KC (Range 4) Frequency & RMS Voltage factor

Frequency	Voltage			
	$0.03 \leq V < 0.1$	$0.1 \leq V < 0.25$	$0.25 \leq V < 1$	$1 \leq V \leq 1.265$
$0.012 \leq f < 0.03$	70	20	10	7
$0.030 \leq f < 0.1$	50	13	6	3
$0.1 \leq f < 0.25$	35	9	4	2
$0.25 \leq f < 1$	25	6	2	1
1	15	4	1	0
$1 < f \leq 3$	17	6	3	2
$3 < f \leq 6$	25	15	10	6
$6 < f \leq 10$	60	30	20	15
$10 < f \leq 20$	Not specified	100	65	50
$20 < f \leq 50$	This range is not used above 20kHz			
$50 < f \leq 200$	This range is not used above 20kHz			

f= frequency in kHz.

Table3

Y Range constant- Range Hold

Range	Inductor		Component Capacitor		Resistor	
	Max	Min	Max	Min	Max	Min
Range1	16mH/f	1mH/f	25uF/f	1.6uF/f	100Ω	6.25Ω
Range2	256mH/f	16mH/f	1600nF/f	100nF/f	1.6kΩ	0.1kΩ
Range3	4100mH/f	256mH/f	100nF/f	6.4nF/f	25.6kΩ	1.6kΩ
Range4*	65H/f	4.1H/f	6400pF/f	400pF/f	410kΩ	25.6kΩ

f= test frequency in kHz

* This range is not used above 20 kHz

Table4

Y Range constant- Auto Range

Range	Inductor		Component Capacitor		Resistor	
	Max	Min	Max	Min	Max	Min
Auto range	65H/f**	1mH/f	25uF/f	400pF/f**	410kΩ**	6.25Ω**

** : Above 20kHz, Cmin = 6.4 nF/f, and Lmax = 4100mH/f

f = test frequency in kHz.

Specifications

Specification accuracy is only applicable when the LCR meter has been warmed up for 30 minutes with an operating temperature of 18°C ~28°C.

Measurement Parameters	Inductance (Ls/Lp)*, Capacitance (Cs/Cp), Resistance (Rs/Rp), Dissipation (D), Quality Factors (Q), Equivalent Series Resistance (ESR) and Equivalent Parallel Resistance (EPR), Impedance (Z), Phase angle of Impedance [degree] (θ).		
Measurement Modes	R/Q, C/D, C/R, L/Q, Z/θ, L/R		
Display Ranges	Primary Display	Inductance (L)	0.00001mH ~ 99999H
		Capacitance (C)	0.00001pF ~ 99999 μ F
		Resistance (R)	0.00001 Ω ~ 99999k Ω
		Absolute of Impedance (Z)	0.00001 Ω ~ 99999k Ω
Secondary Display		Dissipation factor (D) ⁺	0.0001 ~ 9999
		Quality factor (Q)**	0.0001 ~ 9999
		Phase angle of Impedance (degree)	-180.00° ~ 180.00°
		Equivalent Series Resistance (ESR) ⁺	0.0001 Ω ~ 9999 k Ω
		Equivalent Parallel Resistance (EPR) ⁺	0.0001 Ω ~ 9999 k Ω

Dissipation factor (D) ⁺ in ppm	1 ppm ~ 9999 ppm
Quality factor (Q) ^{**} in ppm	1 ppm ~ 9999 ppm
DELTA %	0.00001% ~ 99999%

*s=series, p=parallel ESR=Rs

** with L or R

+ with C

Note: Only LCR-821 has Z/θ and L/R measurement parameters.

If any of these quantities is negative, the “-“ negative indicator is displayed.

Accuracy	LCR-821/819/817	
	R, L, C, Z	0.05%(Basic)
	D, Q	0.0005(Basic)
	θ	0.03° (Basic)
	LCR-829/827/826/816	
	R, L, C, Z	0.10%(Basic)
	D, Q	0.001
	Please refer to the accuracy definition on page132 for details.	
Basic Accuracy	0.05%	LCR-821/819/817
	0.1%	LCR-829/827/826/816
Test Frequency	LCR-821	12Hz~200kHz (504 Steps)
	LCR-819/829	12Hz~100kHz (503 Steps)
	LCR-817/827	12Hz~10kHz (489 Steps)
	LCR-816/826	100Hz~2kHz (245 Steps)
Measurement displays	Value	R/Q, C/D, C/R, L/Q, Z/ θ, L/R *The resolution of primary display (L, C, R or Z) is five digits. *The resolution of secondary display (D, Q, R with C, or R with L) is four digits. *The resolution of secondary display (θ) is 2 digits after decimal place.

	Delta%	DELTA% shows the percent deviation of the measured L, C, R or Z value from a saved NOMINAL VALUE. The deviation is indicated.	
	Delta	Delta is similar to the DELTA% except that the deviation is shown in suitable units (ohms, henries, etc.)	
Measurement Speed	Speed	LCR-816/817/819/821	LCR-826/827/829
	Slow	896ms	Please refer to the Handler timing diagram on page 119 for details.
	Medium	286ms	
	Fast	135ms	
Equivalent circuit	Parallel	L/R, L/Q, C/D, C/R, R/Q	
	Serial	L/R, L/Q, C/D, C/R, R/Q, Z/θ	
Trigger	Auto/Manual		
Average	1-255		
Battery	3V-DC lithium ion (*BR-2/3A) used for memory and calibration data backup. (Recommended replacement every three years. *The battery should only be replaced by a GW Instek approved service center.		
Memory	100 blocks of memory		
Display	240X128 dot matrix C.C.F.L. back lit LCD (contrast adjustable)		
Test voltage	LCR-817/819/827/829/821 LCR-816/826 5mV~1.275V (5mV steps) 0.1V~1.275V (5mV steps) Note: When the test frequency is at 200kHz, test voltage must be greater than 100mV.		
DC bias	Internal	2V	
	External	Up to 30VDC (200mA max), tolerable up to 35VDC.	
Operation Environment	Indoor use Altitude up to 2000M Installation category II Pollution degree 2 Operating temperature 10°C~50°C, <85% relative humidity		
Storage Environment	-20°C~60°C		

Power Source	Line Voltage	100V~240V AC, 50~60Hz/ 400Hz
	Power Consumption	45 Watts maximum
	Fuse	Slow-blow 5X20 mm, 3A/250V UL/CSA 5TT GMD
Dimensions	330mm (W) × 149mm (H) × 437mm (D)	
Weight	5.5kg	

EC Declaration of Conformity

We
GOOD WILL INSTRUMENT CO., LTD.
 No. 7-1, Jhongsing Rd., Tucheng City, Taipei County 236, Taiwan
GOOD WILL INSTRUMENT (SUZHOU) CO., LTD.
 No. 69 Lushan Road, Suzhou New District Jiangsu, China.
 declare that the below mentioned products:
LCR-817/819/827/829/816/826/821
 are herewith confirmed to comply with the requirements set out in
 the Council Directive on the Approximation of the Law of Member
 States relating to Electromagnetic Compatibility (2004/108/EC) and
 Low Voltage Equipment Directive (2006/95/EC).

© **EMC**

EN 61326-1	Electrical equipment for measurement, control and
EN 61326-2-1	laboratory use -- EMC requirements 2006
Conducted and Radiated Emissions CISPR11: 2003+A1: 2004+A2: 2006 Class A	Electrostatic Discharge IEC 61000-4-2: 2001
Current Harmonic EN 61000-3-2: 2006	Radiated Immunity IEC 61000-4-3: 2006+A1: 2007
Voltage Fluctuation EN 61000-3-3: 1995+A1: 2001+A2: 2005	Electrical Fast Transients IEC 61000-4-4: 2004 +Corr.1: 2006 +Corr.2: 2007
-----	Surge Immunity IEC 61000-4-5: 2005
-----	Conducted Susceptibility IEC 61000-4-6: 2003+A1: 2004+A2: 2006
-----	Power Frequency Magnetic field IEC 61000-4-8: 1993+A1: 2000
-----	Voltage Dips/ Interrupts IEC 61000-4-11: 2004

© **Safety**

Low Voltage Equipment Directive 2006/95/EC
Safety Requirements IEC/EN 61010-1:2001

INDEX

Absolute limit settings	series/parallel model..... 124
set bin menu..... 65	Caution symbol..... 5
Admittance	Circuit settings
overview..... 129	handler menu..... 53
Angle overview..... 131	Circuit theory and formula.. 124
Auto/Manual settings	Cleaning the instrument..... 7
handler menu..... 55	Clear bin
Automatic mode	set bin menu..... 67
basic measurement..... 44	Command
Average setting	combining..... 89
basic measurement..... 40	format..... 88
Average settings	forms..... 88
handler menu..... 60	input/output..... 88
Bais voltage..... 34	list..... 90
Basic accuracy	parameter..... 88
specification..... 137	syntax..... 87
Basic measurement..... 29	terminators..... 88
combination..... 30	types..... 87
Bias settings	Conductance
handler menu..... 57	overview..... 126
Bias voltage	Constant voltage factor
specification..... 138	accuracy definition..... 133
Bin functions..... 48	constant voltage setting
Bin menu overview..... 50	basic measurement..... 39
Bin number	Constant voltage settings
set bin menu..... 64	handler menu..... 58
Bin summary..... 70	Declaration of conformity 140
Bin summary overview..... 68	Delay settings
Calibration	handler menu..... 59
open circuit..... 24	Dimensions
short circuit..... 25	specification..... 139
zeroing..... 24	Display
Capacitance	overview..... 30
accuracy definition..... 132	specification..... 138
overview..... 127	Display ranges

specification..... 136	timing..... 119
Display unit settings	Handler menu..... 52
handler menu..... 54	Impedance
Dissipation	accuracy definition..... 132
accuracy definition..... 132	overview..... 129
Dissipation factor	Inductance
overview..... 130	accuracy definition..... 132
EN61010	overview..... 127
measurement category..... 6	series/parallel model..... 124
pollution degree..... 7	Interface..... 111
Environment	LCR viewer
operation..... 7	file settings..... 78
storage..... 8	LCR Viewer
Equivalent circuit model	connection..... 75, 84
overview..... 124	overview..... 74
Equivalent circuit type..... 33	remote measurement..... 80
Equivalent circuits	view data..... 81, 82
specification..... 138	Limit settings
Exit	set bin menu..... 65
set bin menu..... 67	Manual measurement
External voltage bias	basic measurement..... 43
connection..... 22	Measurement
Features..... 11	accuracy definition..... 132
Fixture	basic measurement..... 29
connection..... 21	item and combination..... 12
overview..... 20	Measurement displays
Frequency and voltage factor	specification..... 137
accuracy definition..... 133	Measurement mode..... 33
table1..... 134	Measurement modes
table2..... 134	specification..... 138
Frequency setting	Measurement parameters
basic measurement..... 35	specification..... 136
Frequency settings	Measurement speed..... 31
handler menu..... 54	specification..... 138
Front panel overview..... 13	Measurement units..... 32
Fuse	Measuring
replacement..... 123	air-cored coils..... 28
safety instruction..... 6	Capacitors..... 27
Ground symbol..... 5	Component cases..... 27
Handler interface	Guidelines..... 26
configuration..... 114	Inductors..... 26
Handler Interface	iron-core inductors..... 28
signal overview..... 116	Resistors..... 27

wire capacitance	27	Resistance	
Memory		accuracy definition	132
specification	138	overview	126
Mode settings		series/parallel model	125
handler menu	52	Resistance (C/R, L/R)	
Nominal value		accuracy definition	132
set bin menu	64	Results	
Nominal value setting		bin summary	70
basic measurement	41	RS-232 configuration	112
Operation environment		RS232 remote	72
specification	138	RS232 Settings	73
Parallel circuit selection	33	Run measurement	
Percentage limit settings		basic measurement	43
set bin menu	65	Run measurements	
Power source		handler menu	55
specification	139	Secondary limits	
Power supply		set bin menu	66
safety instruction	6	Secondary measurement	
socket overview	17	accuracy definition	132
Power up sequence	18	Series circuit selection	33
PPM setting		Service contact point	122
basic measurement	38	Set Bin menu	62
Primary measurement		Set Bin menu overview	61
accuracy definition	132	Single mode	
Quality factor		basic measurement	43
accuracy definition	132	Sort settings	
overview	130	set bin menu	63
Range constant		Specification	136
table3	135	Speed settings	
table4	135	handler menu	53
Range hold setting		Storage environment	
basic measurement	40	specification	138
Range settings		Store memory settings	45
handler menu	58	Susceptance	
Reactance		overview	128
overview	128	Terminal command	
Rear panel overview	16	faq	121
Recall calibration settings	46	Test fixture	
Recall memory settings	45	faq	121
Remote		Test frequency	
faq	121	specification	137
remote control		Test speed factor	
interface configuration	112	accuracy definition	133

Test voltage		Weight	
specification	138	specification	139
Tilt stand	18	X variable	
UK power cord	9	accuracy definition	133
Voltage setting		Zeroing	
basic measurement	37	faq	121
Voltage settings		Zeroing Calibration	24
handler menu	56	θ	
Warning symbol	5	accuracy definition	132